

FENTEX

■ ■ ■ *medical*



Precision meets Quality

*Larynx Surgery,
Broncho- and Esophagoscopy*

*Larynx-Chirurgie,
Broncho- und Oesophagoskopie*

Edition 02/2009

The content of this catalogue is the literary property of FENTEX medical GmbH. The reproduction, translation or partial utilization of information is not permitted without prior written authorization from FENTEX medical.

All products shown in this catalogue carry a CE mark and are certified for distribution within the appropriate markets. Please note that some international markets have special certification requirements and that restrictions may apply. Information is available from FENTEX medical upon request.

Please refer to the current version of our general terms and conditions as well as the latest price list for further information on product availability and shipment terms.

We continuously strive to improve and update our products, to always meet or excel our customer's expectations and thus reserve the right to make alterations to our products without prior notice.



FENTEXmedical is certified according to EN ISO 13485: 2003 and MDD 93/42/EEC.

Katalogausgabe 02/2009

Der Inhalt des vorliegenden Kataloges ist das geistige Eigentum der Firma FENTEX medical GmbH. Reproduktionen, Übersetzungen oder auch die teilweise Verwertung von Informationen hieraus sind untersagt bzw. nur nach vorheriger schriftlicher Genehmigung durch die FENTEX GmbH erlaubt.

Bei Verstößen oder Missbrauch behalten wir uns rechtliche Schritte vor.

Die Produkte tragen das CE Zeichen und sind damit für dessen Geltungsbereich zugelassen. Für einzelne geografische Märkte kann eine gesonderte Registrierung bzw. Zertifizierung notwendig sein. Informationen dazu werden auf Anfrage mitgeteilt.

Darüber hinaus gelten die Allgemeinen Geschäftsbedingungen der FENTEX Medical GmbH in der jeweils gültigen Fassung, sowie die jeweils aktuelle Preisliste.

Bitte beachten Sie, dass es in Einzelfällen zu leichten Maßabweichungen kommen kann, die aber die grundlegende Funktion der Produkte nicht beeinträchtigen. Modelländerungen vorbehalten.



FENTEXmedical ist zertifiziert nach EN ISO 13485: 2003 und der Richtlinie 93/42/EWG.



Contact Details

Kontaktinformationen

FENTEXmedical GmbH

take-off GewerbePark
D-78579 Neuhausen ob Eck
Germany

Tel. +49 (0) 7467 - 949 62 0
Fax +49 (0) 7467 - 949 62 17

info@fentexmedical.com
www.fentexmedical.com

Table of Content
Inhaltsübersicht

Operating Laryngoscopes and Accessories Operationslaryngoskope und Zubehör	page Seite	6 - 11
Laryngo- / Pharyngoscopes and Accessories Laryngo- / Pharyngoskope und Zubehör	page Seite	12 - 15
Laryngeal / Rhinoscopic Mirrors Larynx- / Rhinoskopie-Spiegel	page Seite	16 - 18
Laryngeal Syringes, Atomizers Kehlkopfspritzen, Zerstäuber	page Seite	19 - 20
Basic Laryngeal Instruments Allgemeine Kehlkopfinstrumente	page Seite	21 - 25
Instruments for Tracheotomy Instrumente für die Tracheotomie	page Seite	26 - 32
Tracheal Tubes Trachealkanülen	page Seite	33 - 34
Instruments for Endolaryngeal Micro-Surgery Instrumente zur Endolaryngealen Mikrochirurgie	page Seite	35 - 44
Suction Tubes, Injection Needles Saugrohre, Injektionskanülen	page Seite	45 - 46
Naso-Pharyngo-Laryngoscopes, flexible / Accessories Naso-Pharyngo-Laryngoskope, flexibel / Zubehör	page Seite	47 - 49
Rigid Telescopes for Broncho- / Esophagoscopy Starre Endoskope für Broncho- / Oesophagoskopie	page Seite	50 - 57
Optical Instruments Optische Instrumente	page Seite	58 - 59
Broncho-Esophagoscopic Forceps Broncho-Oesophagoskopie-Zangen	page Seite	60 - 63
Instrument Storage and Sterilization Instrumentenlagerung und Sterilisation	page Seite	64
Index Nummernverzeichnis	page Seite	65 - 67

General Information

Allgemeine Information

PRECISION MEETS QUALITY

Our company - FENTEX medical GmbH - is specialized in the development, manufacturing and marketing of surgical instruments, implants and visualization systems for surgery in the head & neck area.

Especially in this part of the human body with its anatomical and functional complexity and high aesthetic demands special skills are required. It is our mission not only to meet but to surpass these requirements with our products and services.

PRECISION MEETS QUALITY

Die FENTEX medical GmbH ist ein Unternehmen, das sich auf Entwicklung, Produktion und Vertrieb chirurgischer Instrumente, Implantate und Visualisierungssysteme für die Kopf- und Halschirurgie spezialisiert hat.

Gerade in diesem Bereich des menschlichen Körpers sind aufgrund der anatomischen und funktionalen Komplexität sowie der hohen ästhetischen Anforderungen besondere Qualitäten gefordert. Es ist unsere Mission, diese Qualitätsanforderungen mit unseren Produkten und Dienstleistungen nicht nur zu erfüllen sondern zu übertreffen.

Quality

Our hand-instruments and endoscopes are exclusively German-made products, manufactured by highly skilled master craftsmen. It takes only the finest quality materials and our specialized know-how to manufacture these products. Meticulous quality controls throughout the entire manufacturing process ensure consistent quality and durability.

Qualität

Die Instrumente und Endoskope werden ausschließlich in Deutschland von qualifizierten Meisterbetrieben produziert. Dabei verwenden wir nur hochwertige Materialien und bringen unser umfassendes Know-How in jeden einzelnen Produktionsschritt ein. Laufende Kontrollen während des gesamten Fertigungsprozesses garantieren ein gleichbleibend hohes Maß an Qualität und Zuverlässigkeit.



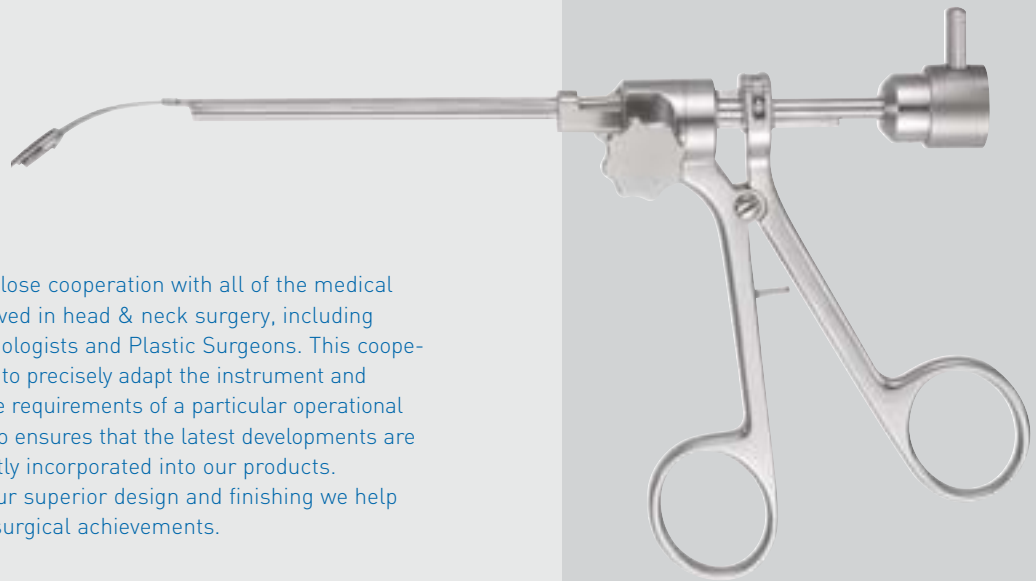

Precision

We maintain a close cooperation with all of the medical specialists involved in head & neck surgery, including ENT-, Otolaryngologists and Plastic Surgeons. This cooperation allows us to precisely adapt the instrument and match it with the requirements of a particular operational technique. It also ensures that the latest developments are being consistently incorporated into our products. Together with our superior design and finishing we help to ensure your surgical achievements.

Präzision

Wir pflegen die enge Kooperation mit Spezialisten aller im Kopf- und Halsbereich tätigen chirurgischen Disziplinen. Dadurch können wir Ihnen für jede Indikation das passende Instrument bereitstellen und halten unser gesamtes Sortiment auf dem aktuellen Stand der medizinischen Entwicklung. Die Präzision in der Ausführung der Instrumente sichert Ihnen den Operationserfolg.



Customer Orientation

We market our products world wide through highly qualified specialist dealers thus achieving a maximum in local customer-service and -support. Our organisation is open to suggestions from clinical users and demand for custom made devices.

The "Bürkle de la Camp" award granted by the German Association for Plastic and Reconstructive Surgery to our founder indicates our dedication to this medical specialty.

Kundenorientierung

Wir vertreiben unsere Produkte weltweit durch ein fachlich versiertes Händlernetz und erreichen dadurch ein Maximum in der Kundenbetreuung vor Ort. Darüber hinaus sind wir auch jederzeit ansprechbar im Hinblick auf die Sonderwünsche unserer Kunden.

Die Verleihung der - Bürkle de la Camp Medaille - der Deutschen Gesellschaft für Plastische und Wiederherstellungschirurgie an unseren Firmeninhaber dokumentiert die enge Kooperation mit den medizinischen Fachdisziplinen.

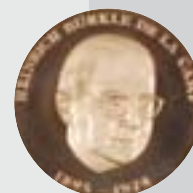

Chest support
Bruststützen



530500FX

Chest Support with Rod, for adults,
for use with standard operating laryngoscopes, rod length 340 mm,
rubber ring Ø 95 mm,

Bruststütze mit Stützstange, für Erwachsene, zum Ansetzen
handelsüblicher Laryngoskope, Stützstange 34 cm lang,
Gummiring-Ø 9,5 cm

530600FX

Rod, for Chest Support, length 240 mm, for children
Stützstange, kurz für Kinder, Länge 24 cm

530501FX

Rubber Ring, Ø 95 mm, only, for 530500FX and 530600FX
Gummiring, Ø 9,5 cm, allein, für 530500FX und 530600FX





530101FX –
530102FX



530104FX –
530105FX







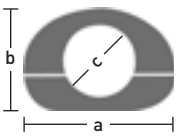

530103FX

Profile Querschnitt	Ref. No./Kat. Nr.	Description Beschreibung	Length Länge
	530101FX	large, for adults / groß, für Erwachsene a/b/c = 29/19/16 mm	170 mm
	530102FX	medium, standard size / mittel, Standard a/b/c = 27/15/14.5 mm	170 mm
	530103FX	small, for narrow anatomy klein, für enge Anatomie a/b/c = 21/13/12 mm	180 mm
	530104FX	anterior commissure vordere Kommissur a/b/c = 26/17/13 x 18 mm	180 mm
	530105FX	long neck / lange Hälse a/b/c = 26/17/13 x 18 mm	220 mm
	530106FX	children / Kinder a/b/c = 21/13/11 mm	150 mm
	530107FX	small children / Kleinkinder a/b/c = 20/12/11 mm	135 mm



Operating Laryngoscopes with distal dilation
OP-Laryngoskope mit distaler Spreizung

Profile Querschnitt	Ref. No./Kat. Nr.	Description Beschreibung	Length Länge
	530201FX	large, for adults / groß, für Erwachsene a/b/c = 29/19/16 mm	170 mm
	530202FX	medium, standard size / mittel, Standard a/b/c = 27/15/14.5 mm	170 mm
	530203FX	small, for narrow anatomy klein, für enge Anatomie a/b/c = 21/13/12 mm	180 mm
	530204FX	anterior commissure vordere Kommissur a/b/c = 26/17/13 x 18 mm	180 mm
	530205FX	long neck / lange Hälse a/b/c = 26/17/13 x 18 mm	220 mm
	530206FX	children / Kinder a/b/c = 21/13/11 mm	150 mm
	530207FX	small children / Kleinkinder a/b/c = 20/12/11 mm	135 mm

For Laser Surgery also in matt or ebony finish (on request)
Für die Laser-Chirurgie auch in mattiert oder geschwärzt (auf Anfrage)



530110FX **Fiber Optic Light Carrier**, for use with Laryngoscopes 530101FX–530105FX and 530201FX–530205FX
Fiberglas-Lichtträger für Laryngoskope 530101FX–530105FX und 530201FX–530205FX

530111FX **same**, but for use with Laryngoscopes 530106FX–530107FX and 530206FX–530207FX
Gleich, aber für Laryngoskope 530106FX–530107FX und 530206FX–530207FX



530210FX **Suction/Smoke Evacuation Tube**, for use with Laryngoscopes 530101FX–530105FX and 530201FX–530205FX
Rauchabsaugrohr, für die Laryngoskope 530101FX–530105FX sowie 530201FX–530205FX

530211FX **Suction/Smoke Evacuation Tube**, for use with Laryngoscopes 530106FX–530107FX and 530206FX–530207FX
Rauchabsaugrohr, für die Laryngoskope 530106FX–530107FX sowie 530206FX–530207FX

530213FX **Injection Cannula**, for Jet-ventilation
Injektionskanüle, für die Jet-Beatmung

Optional:

- Suction and fiber optic light carrier mounted outside the Laryngoscope tube on request.
- Externe Anbringung der Rauchabsaugung und Fiberglas-Lichtträger auf Anfrage.

Operating Laryngoscopes Operationslaryngoskope

530303FX

Laryngoscope by HOLINGER, tube length 180 mm
Laryngoskop nach HOLINGER, Schaftlänge 180 mm

530304FX

same, but tube length 170 mm
gleich, aber Schaftlänge 170 mm

530300FX

Laryngoscope by JACKSON, tube length 120 mm, infants
Laryngoskop nach JACKSON, Schaftlänge 120 mm, Neugeborene

530301FX

same, but tube length 180 mm, adults
gleich, aber Schaftlänge 180 mm, Erwachsene

530302FX

same, but tube length 170 mm, children
gleich, aber Schaftlänge 170 mm, Kinder



Accessories – Teeth Protectors

Zubehör – Zahnschutz



896100FX

Camo Dental Protector, non-sterile,
individually packed, single use
(non-autoclavable)

Camo Zahnschutz, unsteril, Einzelverpackung,
einmal verwendbar (nicht autoklavierbar)



896160FX

Endoragard Teeth Protector, non-sterile,
package of 1 pair (non-autoclavable)

Zahnschutz Endoragard, unsteril,
Packung paarweise (nicht autoklavierbar)



896150FX

Plastic Teeth Protector, non-sterile, may also be used
with Metal Teeth Protector (non-autoclavable)

Zahnschutz aus Plastik, unsteril, kann auch als
Einlage in Zahnschutz aus Metall verwendet
werden (nicht autoklavierbar)



896200FX

Teeth Protector, metal, size 0 (small size)

Zahnschutz, Metall, Fig. 0 (klein)

896201FX

Same, but size 1

Gleich, aber Fig. 1

896202FX

Same, but size 2

Gleich, aber Fig. 2

896203FX

Same, but size 3

Gleich, aber Fig. 3



6 mm Ø

Working length 160 mm

Arbeitslänge 16 cm

521670FX



- autoclavable
- autoklavierbar

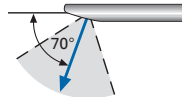

Hi-View Laryngo-Pharyngoscope, 6 mm Ø, 70°, working length 160 mm w. detachable handle, autoclavable

Hi-View Laryngo-Pharyngoskop, 6 mm Ø, 70°, Arbeitslänge 16 cm mit abnehmbarem Handgriff, autoklavierbar

521671FX



- autoclavable
- autoklavierbar

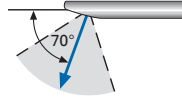

Hi-View Laryngo-Pharyngoscope, 6 mm Ø, 70°, working length 160 mm w. detachable handle, autoclavable, (HM) high magnification

Hi-View Laryngo-Pharyngoskop, 6 mm Ø, 70°, Arbeitslänge 16 cm mit abnehmbarem Handgriff, autoklavierbar, (HM) hohe Vergrößerung



10 mm Ø

Working length 160 mm

Arbeitslänge 16 cm

521170FX



- autoclavable
- autoklavierbar

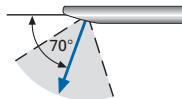

Hi-View Laryngo-Pharyngoskop, 10 mm Ø, 70°, working length 160 mm w. detachable handle, autoclavable

Hi-View Laryngo-Pharyngoskop, 10 mm Ø, 70°, Arbeitslänge 16 cm mit abnehmbarem Handgriff, autoklavierbar

521190FX



- autoclavable
- autoklavierbar

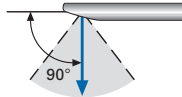

Hi-View Laryngo-Pharyngoskop, 10 mm Ø, 90°, working length 160 mm w. detachable handle, autoclavable

Hi-View Laryngo-Pharyngoskop, 10 mm Ø, 90°, Arbeitslänge 16 cm mit abnehmbarem Handgriff, autoklavierbar

520170FX

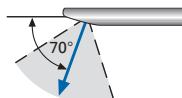

Laryngo-Pharyngoskop, 10 mm Ø, 70°, working length 160 mm w. detachable handle, soakable

Laryngo-Pharyngoskop, 10 mm Ø, 70°, Arbeitslänge 16 cm mit abnehmbarem Handgriff, einlegbar

520190FX

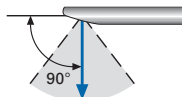

Laryngo-Pharyngoskop, 10 mm Ø, 90°, working length 160 mm w. detachable handle, soakable

Laryngo-Pharyngoskop, 10 mm Ø, 90°, Arbeitslänge 16 cm mit abnehmbarem Handgriff, einlegbar



8 mm Ø

Working length 210 mm

Arbeitslänge 21 cm

520970FX



- autoclavable
- autoklavierbar

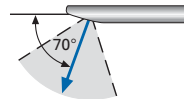

Tele-Laryngoscope, 8 mm Ø, 70°, working length 210 mm with detachable handle, autoclavable

Tele-Laryngoskop, 8 mm Ø, 70°, Arbeitslänge 21 cm mit abnehmbarem Handgriff, autoklavierbar

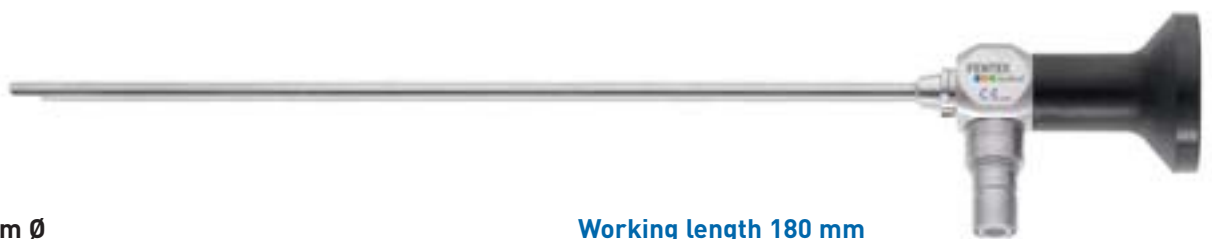

4 mm Ø

Working length 180 mm

Arbeitslänge 18 cm

750270FX



- autoclavable
- autoklavierbar

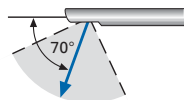

Hi-View Micro-Laryngoscope, 4 mm Ø, 70°, working length 180 mm, autoclavable

Hi-View Mikro-Laryngoskop, 4 mm Ø, 70°, Arbeitslänge 18 cm, autoklavierbar

Fiber Optic Light Cables and Adapters / Telescope Accessories Fiberglas-Lichtleitkabel und Adapter / Zubehör für Endoskope

The Standard Fiber Optic Light Cables (grey) are recommended for use with Halogen Light Sources only. Please use High Performance Light Cables (blue) when connecting a Xenon-Light Source to your endoscope.

Die Verwendung der grauen Standard-Lichtleiter wird nur in Verbindung mit Halogen-Lichtquellen niedriger Leistung empfohlen. Für den Anschluss an Xenon-Lichtquellen empfehlen wir unsere blauen Hochleistungs-Lichtleitkabel.



 **18 min**
134°C

- autoclavable
- autoklavierbar

FENTEX/STORZ Adapter

FENTEX/STORZ Adapter

716500FX

Fiber Optic Cold Light Cable, 3.5 mm Ø,
 length 1.8 m, complete with 2 FENTEX/
 STORZ Adapters, autoclavable

Fiberglas-Lichtkabel, 3,5 mm Ø,
 180 cm Länge komplett mit 2 FENTEX/
 STORZ Adaptern, autoklavierbar

716700FX

Fiber Optic Cold Light Cable, 4.9 mm Ø,
 length 1.8 m, compl. with 2 FENTEX/
 STORZ Adapters, autoclavable

Fiberglas-Lichtkabel, 4,9 mm Ø,
 180 cm Länge kompl. mit 2 FENTEX/
 STORZ Adaptern, autoklavierbar

716702FX

same, but length 2.3 m

wie oben, aber 230 cm lang



863100FX

ULTRA-STOP, 25 ml
 Solution (antifogging),
 Pipette Bottle

ULTRA-STOP, 25 ml
 Lösung (Antibeschlagn-
 mittel), Pipettenflasche



863110FX

ULTRA-STOP, 15 ml
 Solution (antifogging),
 Spray Bottle

ULTRA-STOP, 15 ml
 Lösung (Antibeschlagn-
 mittel), Sprühflasche



863101FX

ULTRA-STOP, 25 ml
 Solution (antifogging),
 Pipette Bottle

ULTRA-STOP, 25 ml
 Lösung (Antibeschlagn-
 mittel), Pipettenflasche

Laryngeal / Rhinoscopic Mirrors
Larynx- / Rhinoskopie- Spiegel

Laryngeal Mirror, stainless steel, autoclavable, threaded shaft, for use with octagonal handle 053800FX, Fig. 00 – Fig. 10 (Ø 8–30 mm)

Kehlkopfspiegel, Edelstahl, autoclavierbar, verschraubbar mit oktagonalem Handgriff 053800FX, Fig. 00 – Fig. 10 (Ø 8–30 mm)



Laryngeal Mirror, stainless steel, autoclavable, with fixed handle, Fig. 00 – Fig. 10 (Ø 8–30 mm)

Kehlkopfspiegel, Edelstahl, autoclavierbar, mit feststehendem Handgriff, Fig. 00 – Fig. 10 (Ø 8–30 mm)



	Size Figur	Ø (mm) Ø (mm)
053720FX	00	8
053700FX	0	10
053701FX	1	12
053702FX	2	14
053703FX	3	16
053704FX	4	18
053705FX	5	20
053706FX	6	22
053707FX	7	24
053708FX	8	26
053709FX	9	28
053710FX	10	30

	Size Figur	Ø (mm) Ø (mm)
054020FX	00	8
054000FX	0	10
054001FX	1	12
054002FX	2	14
054003FX	3	16
054004FX	4	18
054005FX	5	20
054006FX	6	22
054007FX	7	24
054008FX	8	26
054009FX	9	28
054010FX	10	30

053800FX

Mirror Handle, octagonal, overall length 75 mm, for use with mirrors 053700FX to 053720FX

Spiegelhandgriff, oktagonale, Gesamtlänge 7,5 cm, für Kehlkopfspiegel 053700FX bis 053720FX



Sizes of Laryngeal Mirrors, Größen der Kehlkopfspiegel

Size Figur	Ø (mm) Ø (mm)	Size Figur	Ø (mm) Ø (mm)
00	8	5	20
0	10	6	22
1	12	7	24
2	14	8	26
3	16	9	28
4	18	10	30



Laryngeal / Rhinoscopic Mirrors

Larynx- / Rhinoskopie- Spiegel

Laryngeal Mirror, stainless steel, autoclavable, standard shaft, for use with handle 054200FX, Fig. 00 – Fig. 10 (Ø 8–30 mm)

Kehlkopfspiegel, Edelstahl, autoklavierbar, Standardschaft für Handgriff 054200FX, Fig. 00 – Fig. 10 (Ø 8–30 mm)

	Size Figur	Ø (mm) Ø (mm)
054120FX	00	8
054100FX	0	10
054101FX	1	12
054102FX	2	14
054103FX	3	16
054104FX	4	18
054105FX	5	20
054106FX	6	22
054107FX	7	24
054108FX	8	26
054109FX	9	28
054110FX	10	30



Laryngeal Mirror Rhodium, stainless steel, autoclavable, standard shaft, for use with handle 054200FX (Rhodium plated glass) Fig. 00 – Fig. 10 (Ø 8–30 mm)

Kehlkopfspiegel Rhodium, Edelstahl, autoklavierbar, Standardschaft für Handgriff 054200FX (Rhodium-beschichtetes Glas) Fig. 00 – Fig. 10 (Ø 8–30 mm)

	Size Figur	Ø (mm) Ø (mm)
054420FX	00	8
054400FX	0	10
054401FX	1	12
054402FX	2	14
054403FX	3	16
054404FX	4	18
054405FX	5	20
054406FX	6	22
054407FX	7	24
054408FX	8	26
054409FX	9	28
054410FX	10	30

054200FX

Mirror Handle, only, overall length 105 mm, for use with 054100FX to 054420FX

Spiegelhandgriff, alleine, Gesamtlänge 10,5 cm, für Kehlkopfspiegel 054100FX bis 054420FX





717500FX

Mirror Heater, for quick and easy heating of laryngeal mirrors. Safe operation, with electronic controls for automatic activation and deactivation. Quick heating and automatic cooling. Plastic housing, umber grey with LED visual control.

Spiegelwärmer, zur schnellen und einfachen Anwärmung der Kehlkopfspiegel. Elektronische Regelung mit automatischer Aktivierung und Deaktivierung für einen sicheren Betrieb. Schnelles Aufheizen mit anschließend automatischer Abkühlphase. Robustes Kunststoffgehäuse, umbragrau, mit Kontroll-Leuchtdioden

Rhinoscopic Mirror by MICHEL,
 overall length 290 mm

Rhinoskopiespiegel nach MICHEL,
 Gesamtlänge 29 cm

	Size Figur	Ø (mm) Ø (mm)
054210FX	0	10
054212FX	1	12
054214FX	2	14
054216FX	3	16
054218FX	4	18

Spare Mirror Attachment, only,
 for Rhinoscopic Mirror by MICHEL

Spiegelaufsatz, alleine,
 für Rhinoskopiespiegel nach MICHEL

	Size Figur	Ø (mm) Ø (mm)
054220FX	0	10
054222FX	1	12
054224FX	2	14
054226FX	3	16
054228FX	4	18



Laryngeal Syringes, Atomizer
Kehlkopfspritze und Zerstäuber



- 011302FX **Laryngeal Syringe 2 cc, LUER LOCK, replaceable glass cylinder**
Kehlkopfspritze 2 ml, LUER LOCK, auswechselbarer Glaszylinder
- 011305FX **Laryngeal Syringe 5 cc, LUER LOCK, replaceable glass cylinder**
Kehlkopfspritze 5 ml, LUER LOCK, auswechselbarer Glaszylinder
- 011310FX **Laryngeal Syringe 10 cc, LUER LOCK, replaceable glass cylinder**
Kehlkopfspritze 10 ml, LUER LOCK, auswechselbarer Glaszylinder



- 011402FX **Spare Glass Cylinder 2 cc, LUER LOCK, for syringe 011302FX**
Ersatzzylinder 2 ml, LUER LOCK, für Spritze 011302FX
- 011405FX **Spare Glass Cylinder 5 cc, LUER LOCK, for syringe 011305FX**
Ersatzzylinder 5 ml, LUER LOCK, für Spritze 011305FX
- 011410FX **Spare Glass Cylinder 10 cc, LUER LOCK, for syringe 011310FX**
Ersatzzylinder 10 ml, LUER LOCK, für Spritze 011310FX



- 011500FX **Laryngeal Cannula, curved, length 130 mm, for syringes**
011302FX–011310FX
Kehlkopfkanüle, gebogen, Länge 13 cm, für Spritzen
011302FX–011310FX

Laryngeal Syringes, Atomizer
Kehlkopfspritze und Zerstäuber

840402FX

Laryngeal Atomizer by GRUENWALD, cannula bent downward,
replaceable glass

Kehlkopfzerstäuber nach GRUENWALD, mit nach unten gebogener
Kanüle, mit auswechselbarem Glas

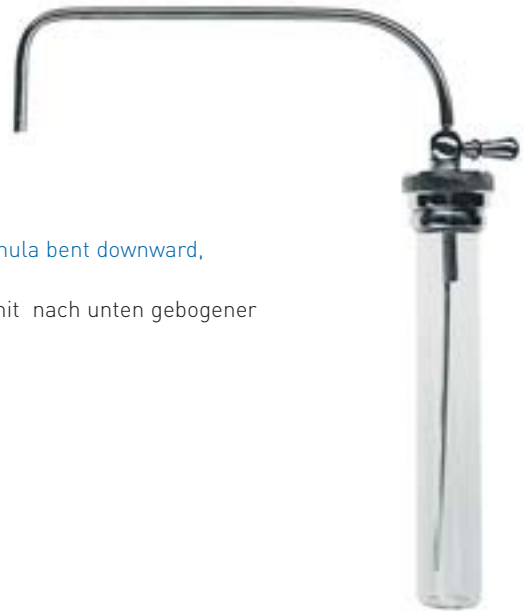

840403FX

Pharyngeal Atomizer by GRUENWALD, cannula bent upward,
replaceable glass

Pharynxzerstäuber nach GRUENWALD, mit aufgebogener Kanüle,
mit auswechselbarem Glas

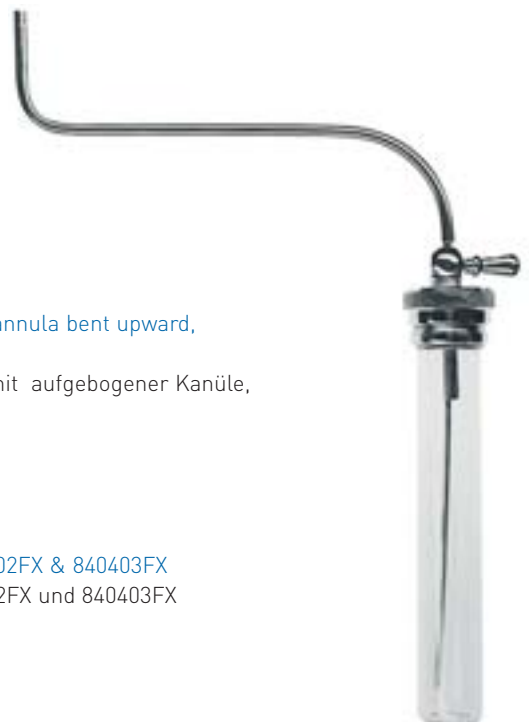

840404FX

Spare Glass, for Laryngeal Atomizer 840402FX & 840403FX
Ersatzglas, für Kehlkopfzerstäuber 840402FX und 840403FX



056100FX **Laryngeal Cotton Applicator by FEIN**, overall length 290 mm
Kehlkopfwatteträger nach FEIN, Gesamtlänge Länge 29 cm



056200FX **Laryngeal Cotton Applicator by PELTESON**, overall length 235 mm
Kehlkopfwatteträger nach PELTESON, Gesamtlänge Länge 23,5 cm



056300FX **Laryngeal Cotton Applicator by KILLIAN**, overall length 250 mm
Kehlkopfwatteträger nach KILLIAN, Gesamtlänge Länge 25 cm

Basic Laryngeal Instruments
Allgemeine Kehlkopfinstrumente



055100FX

Epiglottis Retractor by REICHERT, overall length 240 mm
Epiglottis Retraktor nach REICHERT, Gesamtlänge 24 cm



058100FX

Laryngeal Polyp Forceps by FRAENKEL, overall length 190 mm
Kehlkopfpolypenzange nach FRÄNKEL, Gesamtlänge 19 cm

Basic Laryngeal Instruments Allgemeine Kehlkopfinstrumente



057301FX **Laryngeal Biopsy Forceps**, oval cupped jaws, vertical opening, working length 150 mm
Kehlkopfpolypenzange, ovale Löffel, vertikal öffnend, Arbeitslänge 15 cm

057302FX **Same**, but with horizontal opening
Gleich, aber horizontal öffnend



057303FX **Laryngeal Alligator Forceps**, serrated for foreign body removal, vertical opening, working length 150 mm
Kehlkopfzange Hechtmaul, gezahnt für Fremdkörperentfernung, vertikal öffnend, Arbeitslänge 15 cm

057304FX **Same**, but with horizontal opening
Gleich, aber horizontal öffnend



057500FX **Laryngeal Biopsy Forceps**, round cupped jaws Ø 4 mm, straight, working length 170 mm
Kehlkopf-Probenexzisionszange, runde Löffel Ø 4 mm, gerade, Arbeitslänge 17 cm

057501FX **Same**, but curved upward
Gleich, aber aufgebogen

057502FX **Same**, but curved right
Gleich, aber rechts gebogen

057503FX **Same**, but curved left
Gleich, aber links gebogen

Basic Laryngeal Instruments
Allgemeine Kehlkopfinstrumente



558201FX

Modular Handle, for use with laryngeal extension tube 558620FX
Modularer Handgriff, zur Aufnahme des Führungsrohrs 558620FX
für den Einsatz im Kehlkopfbereich

Attachments for Modular Handle 558201FX
Einsätze für modularen Handgriff 558201FX



558620FX

Extension Tube, for laryngeal application, curved, working length 200 mm,
for use with modular handle 558201FX
Führungsrohr, zum Einsatz im Kehlkopfbereich, gebogen, Arbeitslänge 20 cm,
für modularen Handgriff 558201FX

558630FX

Same, but straight and flexible, working length 300 mm
Gleich, aber gerade und flexibel, Arbeitslänge 30 cm



560101FX

Forceps Tip by FRAENKEL, serrated
Kehlkopfansatz nach FRÄNKEL, gerieft

Basic Laryngeal Instruments
Allgemeine Kehlkopfinstrumente



560501FX **Alligator Tip by SEIFFERT**, serrated
Hechtmaulansatz nach SEIFFERT, grob gerieft



560901FX **Forceps Tip by FRAENKEL**, oval cupped jaws, sharp
Kehlkopfansatz nach FRÄNKEL, ovale Löffel, schneidend



561001FX **Forceps Tip by SCHEINMANN**, angled (lateral) cups
Kehlkopfansatz nach SCHEINMANN, (seitlich) abgewinkelte Löffel



561713FX **Forceps Tip by BRUENINGS**, round cupped jaws, Ø 3 mm
Kehlkopfansatz nach BRUENINGS, runde Löffel, Ø 3 mm



562901FX **Forceps Tip by KRAUSE**, circular biopsy punch through-cutting
Kehlkopfansatz nach KRAUSE, Biopsie Rundstanze, durchschneidend



563001FX **Forceps Tip by CORDES**, biopsy punch square, through-cutting
Kehlkopfansatz nach CORDES, Biopsiestanze viereckig, durchschneidend

Instruments for Tracheotomy
Instrumente für die Tracheotomie



467600FX

Laryngectomy Scissors by KILLIAN, serrated blades, double joint, overall length 210 mm

Laryngofissurschere nach KILLIAN, gezahnte Schneiden, mit Doppelgelenk, Gesamtlänge 21 cm

467707FX

Retractor by BOSE, overall length 70 mm

Tracheotomiespreizer nach BOSE, Gesamtlänge 7 cm



467805FX

Life-Saving Tube by BRUENINGS, outer Ø 5 mm, overall length 200 mm

Intubationsrohr nach BRUENINGS, Außen Ø 5 mm, Gesamtlänge 20 cm

 5 mm

467807FX

Same, but outer Ø 7 mm

Gleich, aber Außen Ø 7 mm

 7 mm

467809FX

Same, but outer Ø 9 mm

Gleich, aber Außen Ø 9 mm

 9 mm

Instruments for Tracheotomy
Instrumente für die Tracheotomie



469108FX

Trachea Trocar by DENKER (UCKERMANN), for intercricothyreotomy, stainless steel trocar with cannula from Silver 835, outer Ø 7.5 mm, overall length 130 mm

Trachea Trokar nach DENKER (UCKERMANN), für die Interkrikothyreotomie, Trokar aus Edelstahl, Kanüle aus 835 Silber, Außen Ø 7,5 mm, Gesamtlänge 13 cm

469110FX

Same, but outer Ø 9 mm

Gleich, aber Außen Ø 9 mm



469317FX

Laryngectomy Retractor by DENECKE, 3 x 3 prongs, overall length 190 mm

Wundsperrerr für die Laryngofissur nach DENECKE, 3 x 3 Zähne, Gesamtlänge 17 cm



463400FX

Tracheal Speculum by WEERDA, overall length 190 mm

Tracheal-Spekulum nach WEERDA, Gesamtlänge 19 cm

Instruments for Tracheotomy
Instrumente für die Tracheotomie



463000FX

Goitre Director-Enucleator by KOCHER, with hole, overall length 165 mm
Kropfsonde nach KOCHER, mit Loch, Gesamtlänge 16,5 cm



463100FX

Trachea Dilator by LABORDE, with three blades, overall length 140 mm
Trachealdilator nach LABORDE, mit drei Blättern, Gesamtlänge 14 cm



463200FX

Trachea Dilator by TROUSSEAU, with two blades, overall length 140 mm
Trachealdilator nach TROUSSEAU, mit zwei Blättern, Gesamtlänge 14 cm



463300FX

Goitre Scissors by SCHOEMAKER, slightly curved, overall length 150 mm
Kropfschere nach SCHOEMAKER, leicht gebogen, Gesamtlänge 15 cm

Instruments for Tracheotomy
Instrumente für die Tracheotomie

463600FX

Biopsy Handle CAMECO, suitable for standard single use syringes with 20 cc
Handgriff für die Feinnadelbiopsie CAMECO, passend für standard 20 ml Einmalspritzen



Standard Artery Forceps, without ratchet, straight, overall length 120 mm
Standard Arterienklemme, ohne Sperre, gerade, Gesamtlänge 12 cm

Ref. Number Katalog Nr.	Type / Figur	Overall length / Gesamtlänge cm
085712FX	straight / gerade	12
085714FX	straight / gerade	14
085812FX	curved / gebogen	12
085814FX	curved / gebogen	14
086814FX	strongly curved stark gebogen	14

Instruments for Tracheotomy
Instrumente für die Tracheotomie



464100FX



Retractor by SENN-MILLER, sharp prongs, overall length 160 mm
Wundhäkchen nach SENN-MILLER, scharfe Zähne, Gesamtlänge 16 cm

464200FX



Same, but blunt prongs
Gleich, aber stumpf



465118FX

Slender Clamp, delicate pattern for parotis or similar procedures, serrated jaws, straight, with ratchet, overall length 180 mm

Schlanke Klemme, sehr feines Modell für die Hals-Chirurgie, geriefte Maulteile, gerade, mit Sperre, Gesamtlänge 18 cm

465318FX

Same, but straight, serrated jaws with 1:2 teeth
Gleich, aber gerade, geriefte Maulteilen 1:2 Zähnen



465418FX

Same, but curved, serrated jaws
Gleich, aber gebogen, geriefte Maulteilen, anatomisch

465618FX

Same, but curved, serrated jaws with 1:2 teeth
Gleich, aber gebogen, geriefte Maulteilen 1:2 Zähnen



467000FX

Thymus Retractor by SCHOENBORN, overall length 210 mm
Schildrüsenhaken nach SCHOENBORN, Gesamtlänge 21 cm



Trachea Retractors, sharp or blunt, 1 to 4 prongs, overall length 160 mm
Trachealhaken, scharfe oder stumpfe Zahnung, ein bis 4 Zähne, Gesamtlänge 16 cm

Ref. No./Kat. Nr.	No. of prongs Anzahl Zähne	Type / Art
467101FX	1	sharp / scharf
467102FX	2	sharp / scharf
467103FX	3	sharp / scharf
467104FX	4	sharp / scharf
468101FX	1	blunt / stumpf
468102FX	2	blunt / stumpf
468103FX	3	blunt / stumpf
468104FX	4	blunt / stumpf



084114FX

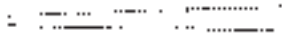

Artery Forceps by PEAN, delicate, straight, overall length 140 mm
Arterienklemme nach PEAN, fein, gerade, Gesamtlänge 14 cm

084214FX



Same, but curved
Gleich, aber gebogen

084314FX



Artery Forceps by KOCHER, delicate, straight, with 1:2 teeth,
overall length 140 mm
Arterienklemme nach KOCHER, fein, gerade, mit 1:2 Zähnen,
Gesamtlänge 14 cm

084414FX



Same, but curved
Gleich, aber gebogen

Tracheal Tubes
Tracheal Kanülen



- Outer tube closed
- Inner tube closed
- Außenrohr geschlossen
- Innenrohr geschlossen

Tracheal Tube by CHEVALIER-JACKSON, silver plated (German silver)

Trachealkanüle nach CHEVALIER-JACKSON, versilbert (Neusilber)

	Size Figur	Ø Outer Ø Außen
470100FX	0	4 mm
470101FX	1	5 mm
470102FX	2	6 mm
470103FX	3	7 mm
470104FX	4	8 mm
470105FX	5	9 mm
470106FX	6	10 mm
470107FX	7	11 mm
470108FX	8	12 mm
470109FX	9	13 mm

Tracheal Tube by CHEVALIER-JACKSON, Sterling silver

Trachealkanüle nach CHEVALIER-JACKSON, Silber

	Size Figur	Ø Outer Ø Außen
470200FX	0	4 mm
470201FX	1	5 mm
470202FX	2	6 mm
470203FX	3	7 mm
470204FX	4	8 mm
470205FX	5	9 mm
470206FX	6	10 mm
470207FX	7	11 mm
470208FX	8	12 mm
470209FX	9	13 mm



- Outer tube closed
- Inner tube closed
- Außenrohr geschlossen
- Innenrohr geschlossen

Tracheal Tube by LUER, silver plated (German silver)

Trachealkanüle nach LUER, versilbert (Neusilber)

	Size Figur	Ø Outer Ø Außen
480100FX	0	4 mm
480101FX	1	5 mm
480102FX	2	6 mm
480103FX	3	7 mm
480104FX	4	8 mm
480105FX	5	9 mm
480106FX	6	10 mm
480107FX	7	11 mm
480108FX	8	12 mm
480109FX	9	13 mm

Tracheal Tube by LUER, Sterling silver

Trachealkanüle nach LUER, Silber

	Size Figur	Ø Outer Ø Außen
480200FX	0	4 mm
480201FX	1	5 mm
480202FX	2	6 mm
480203FX	3	7 mm
480204FX	4	8 mm
480205FX	5	9 mm
480206FX	6	10 mm
480207FX	7	11 mm
480208FX	8	12 mm
480209FX	9	13 mm

Design with sieve or tube window on request

Modelle mit Sieb oder Fenster auf Anfrage

Tracheal Tubes
Tracheal Kanülen



- Outer tube closed
- Inner tube closed
- Außenrohr geschlossen
- Innenrohr geschlossen

Tracheal Tube with Speaking Valve by LUER, silver plated (German silver)

Trachealkanüle mit Sprechventil nach LUER, versilbert (Neusilber)

	Size Figur	Ø Outer Ø Außen
490104FX	4	8 mm
490105FX	5	9 mm
490106FX	6	10 mm
490107FX	7	11 mm
490108FX	8	12 mm
490109FX	9	13 mm

Tracheal Tube with Speaking Valve by LUER, Sterling silver

Trachealkanüle mit Sprechventil nach LUER, Silber

	Size Figur	Ø Outer Ø Außen
490204FX	4	8 mm
490205FX	5	9 mm
490206FX	6	10 mm
490207FX	7	11 mm
490208FX	8	12 mm
490209FX	9	13 mm

Design with sieve or tube window on request

Modelle mit Sieb oder Fenster auf Anfrage



The diameter is measured at the outer end of the tracheal tube
 Der Durchmesser wird an der Spitze des Außenrohres gemessen

The length is measured from the shield along the outer curvature to the end of the tube

Die Länge wird vom Schild aus, entlang des Außenbogens bis zur Spitze der Kanüle gemessen

Diameter / Durchmesser

Size/Fig.	0	1	2	3	4	5	6	7	8	9
Outer Ø mm Außen Ø mm	4	5	6	7	8	9	10	11	12	13
Tube length mm Länge des Außenrohrs mm	45	50	55	60	65	70	75	80	85	90

Instruments for Endolaryngeal Micro-Surgery
Instrumente zur endolaryngealen Mikrochirurgie



220 mm



Rotating Instruments for Endo-Laryngeal Microsurgery, finger post facilitates, easy 360° rotation, working length 220 mm

Drehbare Instrumente zur endolaryngealen Mikrochirurgie, drehbar um 360° durch einfache Fingerbewegung, Nutzlänge 22 cm

532303FX



Cutting Forceps with round cupped jaws, Ø 2mm, double action, curved
Löffelzange schneidend, Ø 2 mm, mit doppelbeweglichem Maulteil, gebogen

532306FX



Alligator Forceps, serrated jaws, double action, curved
Fasszängchen gerieft, mit doppelbeweglichem Maulteil, gebogen

532307FX



Alligator Forceps, with straight triangular jaws, moveable upper jaw
Fasszängchen gerieft, mit dreieckigem Ausschnitt und einfach beweglichen, nach oben gebogenen Maulteilen

532310FX





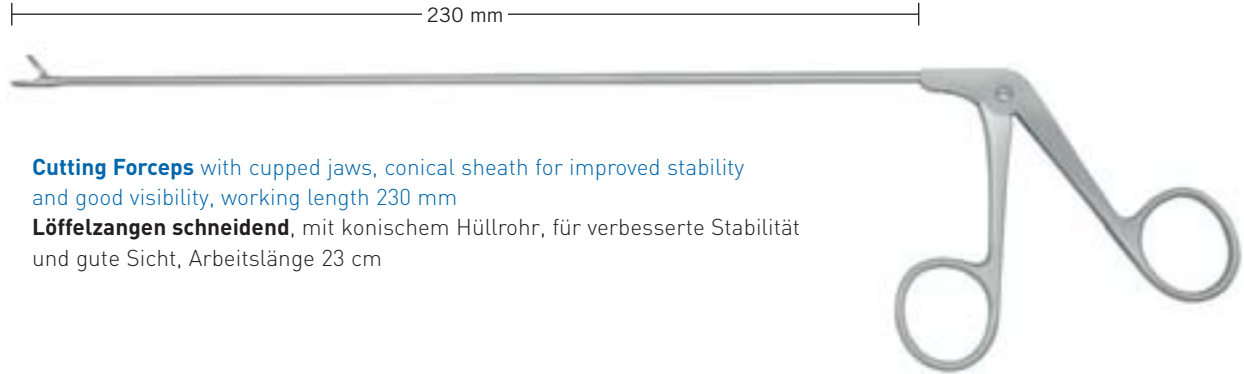







Scissors, curved
Schere, gebogen



Cutting Forceps with cupped jaws, conical sheath for improved stability and good visibility, working length 230 mm



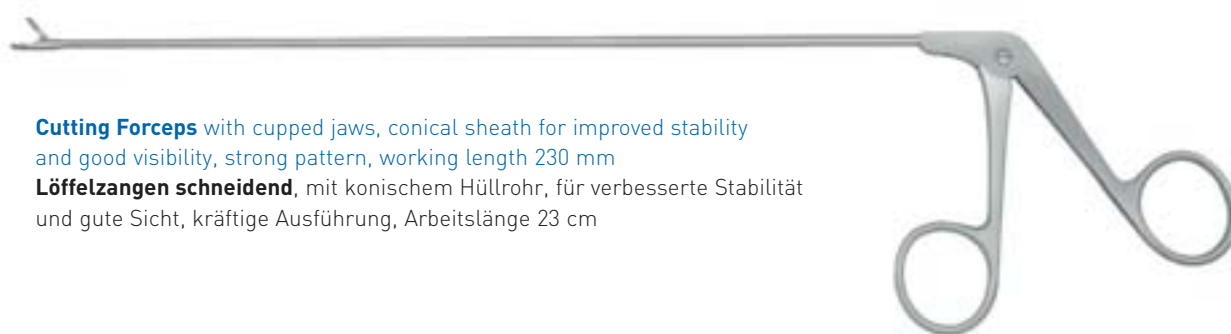

Löffelzangen schneidend, mit konischem Hüllrohr, für verbesserte Stabilität und gute Sicht, Arbeitslänge 23 cm

	Ref. Number Katalog Nr.	Cupped jaws / Löffelmaul Ø 2 mm	Distal tip Distales Ende
	532101FX	round / rund	straight / gerade
	532102FX	round / rund	curved upward / aufwärts gebogen
	532103FX	round / rund	curved right / nach rechts gebogen
	532104FX	round / rund	curved left / nach links gebogen
	532150FX	round / rund	curved upward right nach rechts aufgebogen
	532151FX	round / rund	curved upward left nach links aufgebogen
	532152FX	round / rund	straight horizontal opening, curved right gerade, horizontal nach rechts öffnend
	532153FX	round / rund	straight horizontal opening, curved left gerade, horizontal nach links öffnend
	532250FX	oval long / oval spitz	curved upward / aufgebogen
	532251FX	oval long / oval spitz	curved upward, opening right aufgebogen nach rechts öffnend
	532252FX	oval long / oval spitz	curved upward, opening left aufgebogen nach links öffnend

Instruments for Endolaryngeal Micro-Surgery
Instrumente zur endolaryngealen Mikrochirurgie



Cutting Forceps with cupped jaws, conical sheath for improved stability and good visibility, strong pattern, working length 230 mm
Löffelzangen schneidend, mit konischem Hüllrohr, für verbesserte Stabilität und gute Sicht, kräftige Ausführung, Arbeitslänge 23 cm

	Ref. Number Katalog Nr.	Cupped jaws / Löffelmaul Ø mm	Distal tip Distales Ende
	532140FX	oval / oval 3 x 5 mm	straight / gerade
	532141FX	round / rund 4 mm	straight / gerade
	532142FX	round / rund 4 mm	curved upward / aufgebogen
	532143FX	round / rund 4 mm	curved right / nach rechts gebogen
	532144FX	round / rund 4 mm	curved left / nach links gebogen

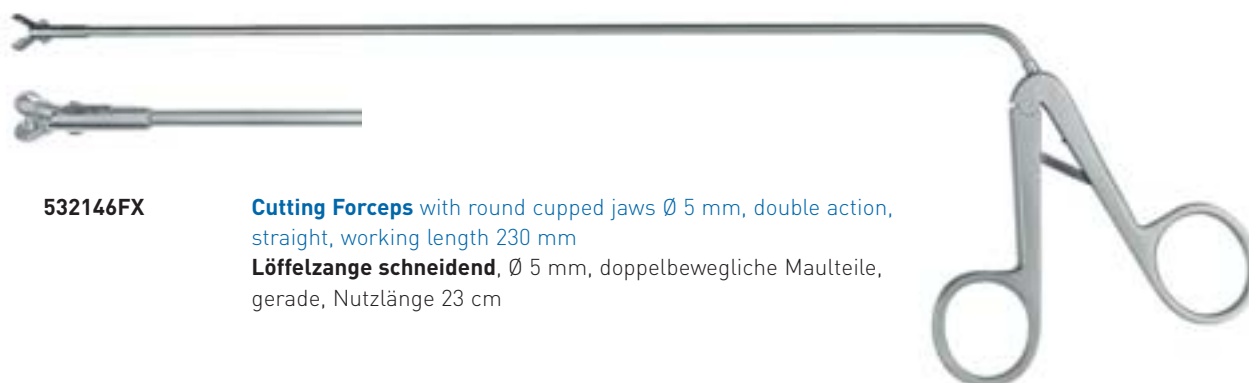



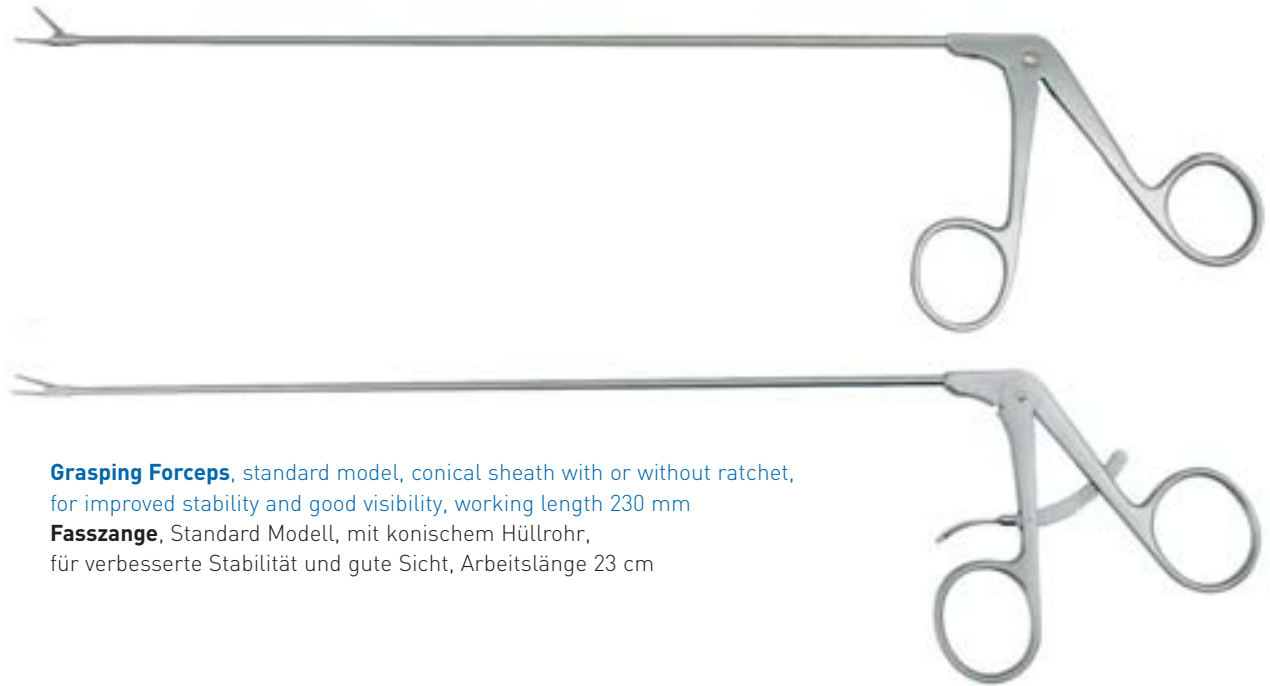









532146FX **Cutting Forceps** with round cupped jaws Ø 5 mm, double action, straight, working length 230 mm
Löffelzange schneidend, Ø 5 mm, doppelbewegliche Maulteile, gerade, Nutzlänge 23 cm



Grasping Forceps, standard model, conical sheath with or without ratchet, for improved stability and good visibility, working length 230 mm

Fasszange, Standard Modell, mit konischem Hüllrohr, für verbesserte Stabilität und gute Sicht, Arbeitslänge 23 cm





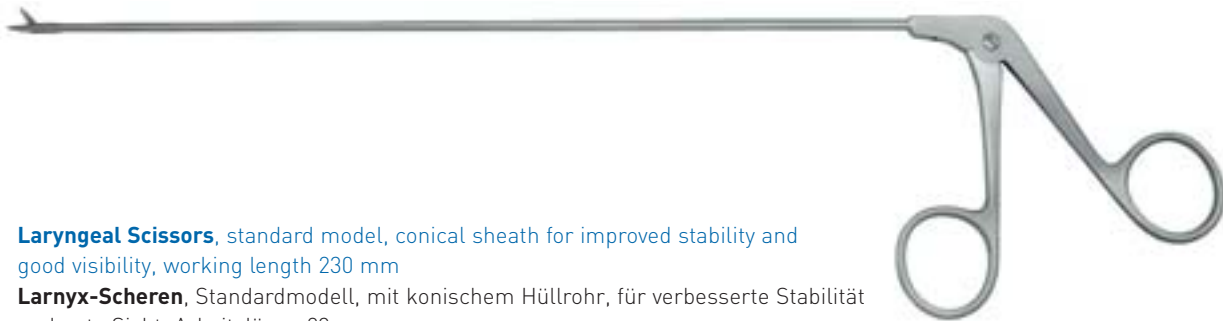

	Ref. No./Kat. Nr.	Forceps (Fcps) Zangen	Description Beschreibung
	532205FX	Artery Fcps. Arterienklemme	with ratchet, serrated, straight mit Sperre, gerieft, gerade
	532105FX	Alligator Fcps. Fasszange	serrated, straight gerieft, gerade
	532106FX	Alligator Fcps. Fasszange	serrated, curved right gerieft, nach rechts gebogen
	532107FX	Alligator Fcps. Fasszange	serrated, curved left gerieft, nach links gebogen
	532315FX	Alligator Fcps. Fasszange	serrated, horizontal opening straight gerieft, horizontal öffnend, gerade
	532154FX	Alligator Fcps. Fasszange	serrated, curved upward gerieft, aufgebogen
	532254FX	Alligator Fcps. Fasszange	serrated, horizontal opening curved upward gerieft, horizontal öffnend, aufgebogen
	532155FX	Forceps Fasszängchen	triangular jaws, curved up, opening right mit dreieckigem Maul, aufgebogen, rechts öffnend
	532156FX	Forceps Fasszängchen	triangular jaws, curved upward, opening left mit dreieckigem Maul, aufgebogen, links öffnend
	532158FX	Forceps Fasszängchen	triangular jaws, straight mit dreieckigem Maul, gerade
	532159FX	Forceps Fasszängchen	triangular jaws, curved upward, straight opening mit dreieckigem Maul, aufgebogen, gerade öffnend
	532168FX	by ARNOLD Vocal Cord Holding Fcps ARNOLD Stimmband-Haltezange	triangular jaws, for right side mit dreieckigem Maul, für rechte Seite
	532169FX	same, but gleich, aber	triangular jaws, for left side mit dreieckigem Maul, für linke Seite

Instruments for Endolaryngeal Micro-Surgery
Instrumente zur endolaryngealen Mikrochirurgie







Laryngeal Scissors, standard model, conical sheath for improved stability and good visibility, working length 230 mm

Larynx-Scheren, Standardmodell, mit konischem Hüllrohr, für verbesserte Stabilität und gute Sicht, Arbeitslänge 23 cm

	Ref. No./Kat. Nr.	Description / Beschreibung
	532108FX	straight / gerade
	532109FX	curved upward 45° / aufgebogen 45°
	532215FX	curved upward 15° / aufgebogen 15°
	532110FX	curved right / nach rechts gebogen
	532111FX	curved left / nach links gebogen
	532157FX	straight, horizontal cutting / gerade horizontal schneidend





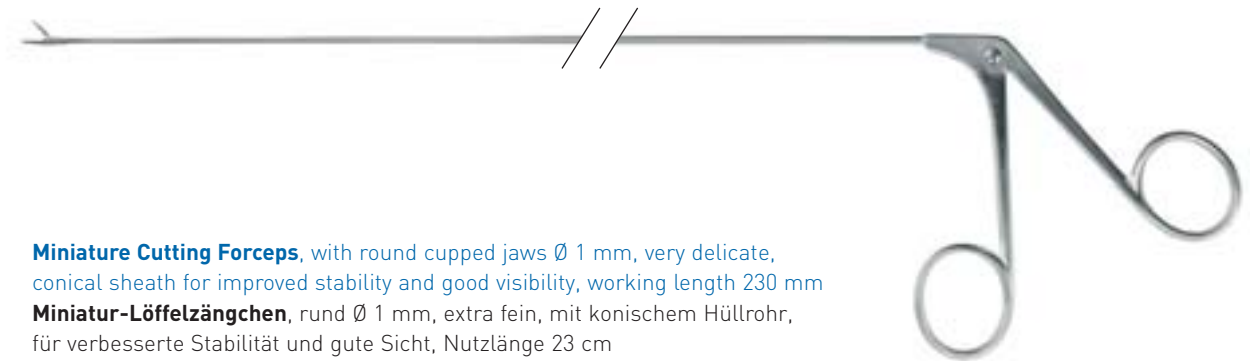

Miniature Scissors, very delicate, conical sheath, working length 230 mm

Miniatur-Scherchen, extra fein, konisch zulaufender Schaft, Nutzlänge 23 cm





	Ref. No./Kat. Nr.	Description / Beschreibung
	532180FX	straight / gerade
	532181FX	curved upward 45° / aufgebogen 45°
	532182FX	curved right / nach rechts gebogen
	532183FX	curved left / nach links gebogen



Miniature Cutting Forceps, with round cupped jaws Ø 1 mm, very delicate, conical sheath for improved stability and good visibility, working length 230 mm
Miniatur-Löffelzängchen, rund Ø 1 mm, extra fein, mit konischem Hüllrohr, für verbesserte Stabilität und gute Sicht, Nutzlänge 23 cm

	Ref. No./Kat. Nr.	Description / Beschreibung
	532160FX	straight / gerade
	532161FX	curved upward / aufgebogen
	532162FX	curved right / nach rechts gebogen
	532163FX	curved left / nach links gebogen
	532164FX	curved upward right / nach rechts aufgebogen
	532165FX	curved upward left / nach links aufgebogen

Miniature Forceps, very delicate, serrated, conical sheath, working length 230 mm
Miniatur-Fasszängchen, extra fein, gerieft, konisch zulaufender Schaft, Nutzlänge 23 cm

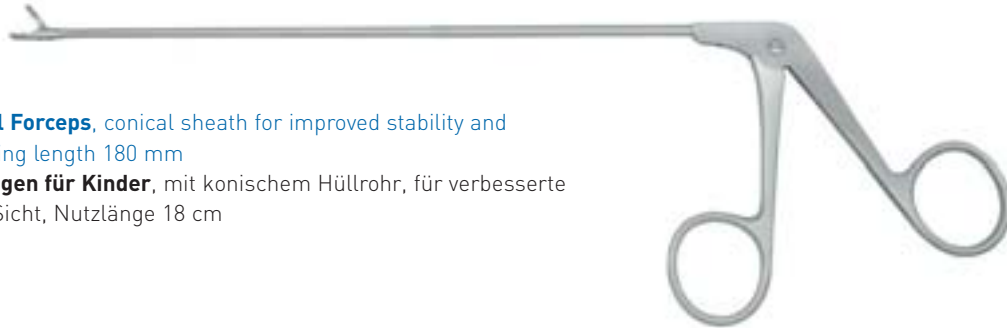

	Ref. No./Kat. Nr.	Description / Beschreibung
	532170FX	straight / gerade
	532171FX	curved upward / aufgebogen
	532172FX	curved right / nach rechts gebogen
	532173FX	curved left / nach links gebogen
	532176FX	with triangular jaws, curved right mit dreieckigem Maul, nach rechts gebogen
	532177FX	with triangular jaws, curved left mit dreieckigem Maul, nach links gebogen

Pediatric Instrument Set for Endolaryngeal Microsurgery
Instrumentarium für Kinder zur endolaryngealen Mikrochirurgie



Pediatric Laryngeal Forceps, conical sheath for improved stability and good visibility, working length 180 mm







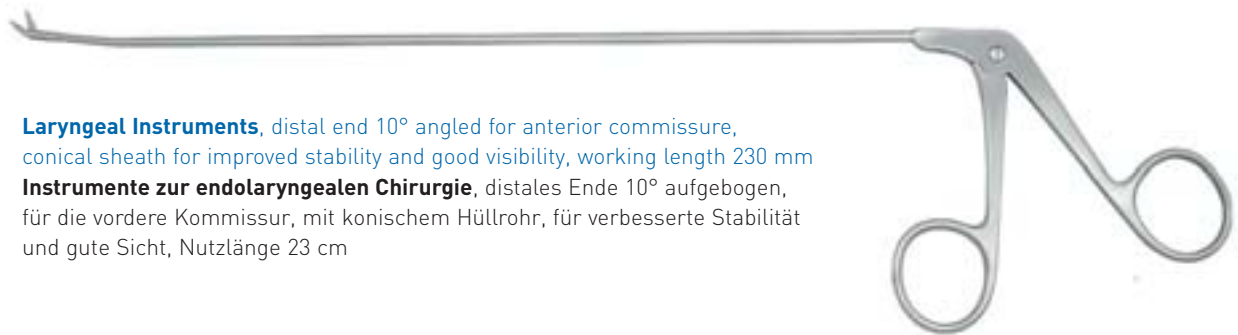

Laryngoskopie-Zangen für Kinder, mit konischem Hüllrohr, für verbesserte Stabilität und gute Sicht, Nutzlänge 18 cm

	Ref. No./Kat. Nr.	Forceps (Fcps) Zangen	Description / Beschreibung
	532002FX	Cutting Fcps. Zange	cupped jaws Ø 2mm, straight Löffelmaul Ø 2 mm, gerade
	532003FX	Cutting Fcps. Zange	cupped jaws Ø 2mm, curved upward Löffelmaul Ø 2 mm, aufgebogen
	532004FX	Cutting Fcps. Zange	cupped jaws Ø 3mm, straight Löffelmaul Ø 3 mm, gerade
	532005FX	Cutting Fcps. Zange	cupped jaws Ø 3mm, curved upward Löffelmaul Ø 3 mm, aufgebogen
	532006FX	Cutting Fcps. Zange	cupped jaws Ø 1mm, straight Löffelmaul Ø 1 mm, gerade
	532007FX	Cutting Fcps. Zange	cupped jaws Ø 1mm, curved upward Löffelmaul Ø 1 mm, aufgebogen
	532010FX	Alligator Fcps Fasszange	serrated, straight gerieft, gerade
	532020FX	Scissors Schere	straight gerade
	532021FX	Scissors Schere	curved upward 45° aufgebogen 45°
	532022FX	Scissors Schere	curved right nach rechts gebogen
	532023FX	Scissors Schere	curved left nach links gebogen
	532030FX	Cutting Fcps. Zange	cupped jaws Ø 4mm, horizontal opening, distal end malleable Löffelmaul Ø 4 mm, horizontal öffnend, vorderes Teil biegsam

Instruments for Endolaryngeal Microsurgery
Instrumente zur endolaryngealen Mikrochirurgie



Laryngeal Instruments, distal end 10° angled for anterior commissure, conical sheath for improved stability and good visibility, working length 230 mm
Instrumente zur endolaryngealen Chirurgie, distales Ende 10° aufgebogen, für die vordere Kommissur, mit konischem Hüllrohr, für verbesserte Stabilität und gute Sicht, Nutzlänge 23 cm

	Ref. No./Kat. Nr.	Forceps (Fcps) Zangen	Description / Beschreibung
	532201FX	Cutting Fcps. Zange	round cupped jaws Ø 2mm, straight rundes Löffelmaul Ø 2 mm, gerade
	532202FX	Cutting Fcps. Zange	round cupped jaws Ø 2mm, curved upward rundes Löffelmaul Ø 2 mm, aufgebogen
	532203FX	Cutting Fcps. Zange	round cupped jaws Ø 2mm, curved right rundes Löffelmaul Ø 2 mm, nach rechts gebogen
	532204FX	Cutting Fcps. Zange	round cupped jaws Ø 2mm, curved left rundes Löffelmaul Ø 2 mm, nach links gebogen
	532208FX	Scissors Schere	straight gerade
	532209FX	Scissors Schere	curved upward 45° aufgebogen 45°
	532110FX	Scissors Schere	curved right nach rechts gebogen
	532111FX	Scissors Schere	curved left nach links gebogen

Instruments for Endolaryngeal Microsurgery
Instrumente zur endolaryngealen Mikrochirurgie

532136FX

Needle Holder self-retaining, with ratchet, conical sheath for improved stability and good visibility, working length 230 mm
Nadelhalter selbsthaltend, mit Sperre, konisches Hüllrohr für verbesserte Stabilität und gute Sicht, Nutzlänge 23 cm



532137FX

Needle Holder for Endo-Laryngoscopy, delicate, with round serrated jaws, Ø 1.6 mm curved upward, self-retaining, with ratchet, working length 230 mm
Nadelhalter für die Endo-Laryngoskopie, fein, mit abgerundeten und gezahnten Maulteilen, Ø 1,6 mm, aufgebogen, selbsthaltend, mit Sperre, Nutzlänge 23 cm



532138FX

Atraumatic Vocal Cord Retractor, self-retaining, with ratchet, working length 230 mm
Atraumatischer Spreitzer für Stimm- und Taschenbänder, selbsthaltend, mit Sperre, Nutzlänge 23 cm



Suction tube only, forceps not included
Saugrohr alleine, ohne Instrument

532200FX

Smoke Evacuation Tube, for conical Larynx instruments (Ø 2 - 1 mm)
Rauchgasabsaugung, für konische Rohrerschaft-Instrumente (Ø 2 - 1 mm)















532300FX

Smoke Evacuation Tube, for conical Larynx instruments (Ø 3 - 2 mm)
Rauchgasabsaugung, für konische Rohrerschaft-Instrumente (Ø 3 - 2 mm)

Instruments for Endolaryngeal Microsurgery
Instrumente zur endolaryngealen Mikrochirurgie

Instruments for Laryngeal Microsurgery, working length 230 mm
Instrumente zur endolaryngealen Mikrochirurgie, Nutzlänge 23 cm

	Ref. No./Kat. Nr.	Forceps (Fcps) Zangen	Description / Beschreibung
	532113FX	Knife Messer	round Ø 2.5mm, angled 45° rund Ø 2,5 mm, abgewinkelt 45°
	532114FX	Knife / Messer	round, vertical cutting / rund, vertikal schneidend
	532115FX	Knife / Messer	oval, straight / oval, gerade
	532116FX	Knife / Messer	straight cutting / gerader Schnitt
	532216FX	Knife / Messer	sickle shaped, curved / sichelförmig gebogen
	532117FX	Knife / Messer	golfstick shaped / golfschläger-förmig
	532118FX	Hook / Häkchen	blunt, with probe end / stumpf, mit Sondenknopf
	532119FX	Hook / Häkchen	sharp / scharf
	532120FX	Needle Umstechungsnadel	curved to right nach rechts gebogen
	532121FX	Needle Umstechungsnadel	curved to left nach links gebogen
	532122FX	Elevator Saugraspatorium	with suction channel mit Saugkanal
	532123FX	Knot Tier Knotenführer	- -
	532124FX	Hook Häkchen	with probe end, angled 90° mit Sondenknopf, abgewinkelt 90°

532125FX

Handle, for use with 532113FX – 532216FX
Handgriff, für 532113FX – 532216FX



164200FX

Handle by HEERMANN, black finish, for use with 532113FX – 532216FX
Handgriff nach HEERMANN, schwarz, für 532113FX – 532216FX



Sucton Tubes / Injection Needles

Saugrohre / Injektionskanülen

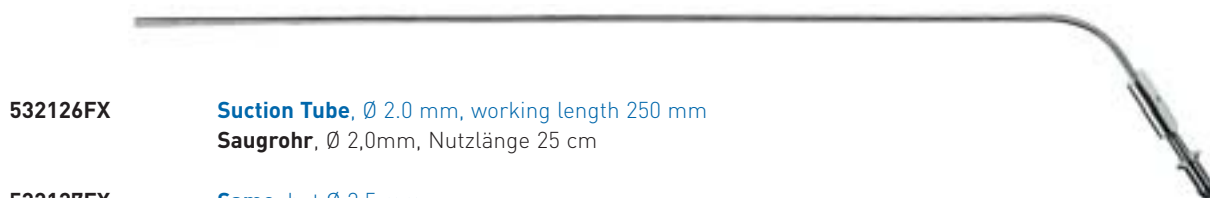

532126FX **Suction Tube**, Ø 2.0 mm, working length 250 mm
Saugrohr, Ø 2,0mm, Nutzlänge 25 cm

532127FX **Same**, but Ø 2.5 mm
Gleich, aber Ø 2,5 mm

532128FX **Same**, but Ø 3.0 mm
Gleich, aber Ø 3,0 mm

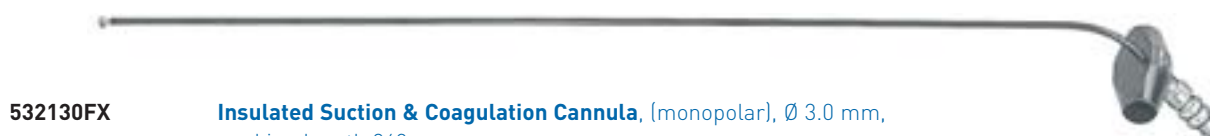

532130FX **Insulated Suction & Coagulation Cannula**, (monopolar), Ø 3.0 mm,
working length 260 mm
Saug-und Koagulationsrohr, monopolar, Ø 3,0 mm, Nutzlänge 26 cm

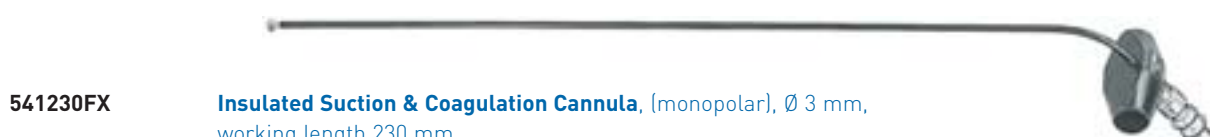

541230FX **Insulated Suction & Coagulation Cannula**, (monopolar), Ø 3 mm,
working length 230 mm
Monopolares Koagulations-Saugrohr, isoliert, Ø 3 mm,
Nutzlänge 23 cm

Please note: Never use Laser and Cauterization simultaneously.

Achtung: Niemals Laserbehandlung und elektrische HF-Chirurgie simultan betreiben.



532228FX **Cotton Carrier**, serrated, twisted end, Ø 2.5 mm, length 280 mm
Watteträger, spiralförmig gerieft, Ø 2,5 mm, Länge 28 cm

Sucton Tubes/Injection Needles

Saugrohre/Injektionskanülen

532230FX

Injection Needle, LUER-LOCK, bayonet shaped, working length 230 mm
Injektionsnadel, LUER-LOCK, bajonett gebogen, Nutzlänge 23 cm

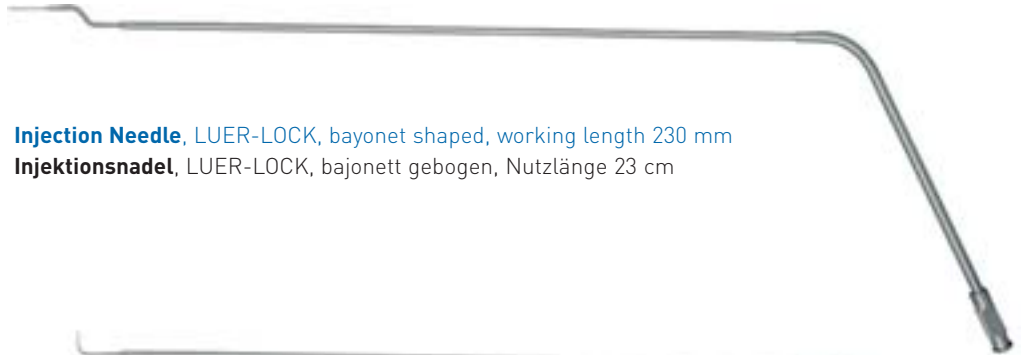

532231FX

Same, but curved upward 90°
Gleich, aber aufgebogen 90°



541125FX

Suction Tube, cut-off hole, special black finish for Laser surgery, Ø 2.5 mm, working length 230 mm
Saugrohr, mit Unterbrecherloch, speziell geschwärzt für die Laserchirurgie, Ø 2,5 mm, Nutzlänge 23 cm

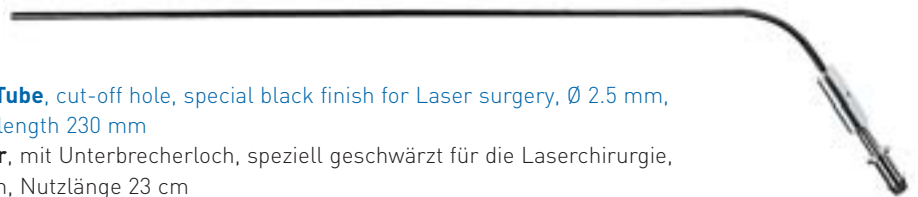

541130FX

Same, but Ø 3 mm
Gleich, aber Ø 3 mm

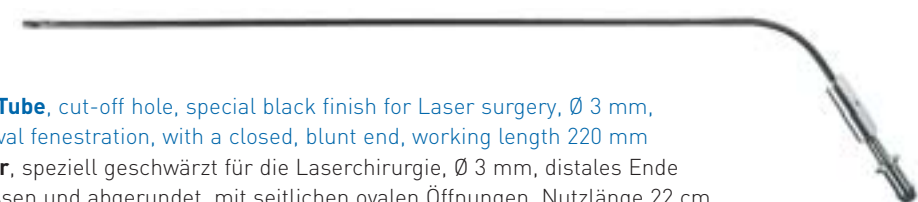

541133FX

Suction Tube, cut-off hole, special black finish for Laser surgery, Ø 3 mm, lateral oval fenestration, with a closed, blunt end, working length 220 mm
Saugrohr, speziell geschwärzt für die Laserchirurgie, Ø 3 mm, distales Ende geschlossen und abgerundet, mit seitlichen ovalen Öffnungen, Nutzlänge 22 cm

Naso-Pharyngo-Laryngoscopes, flexible Naso-Pharyngo-Laryngoskope, flexibel

Flexible Fiberscope with high resolution image bundle and improved optical system. Soakable in disinfection solution, cold disinfection with EO, FO, STERIS.

Smallest tissue pathology can now be visualized and treated immediately. The endoscopes allow to securely distinguish between healthy tissue and for example metaplastic morphologies in the boarder region of Lesions.

Fiberskop mit hochauflösendem Bildleiter und verbesserter Okular und Objektivoptik. Einlegbar in Desinfektionslösung, Kaltsterilisation EO, FO, STERIS.

Schleimhautveränderungen von wenigen Millimetern Durchmesser werden jetzt sichtbar und können sofort behandelt werden. War bisher die Abgrenzung der Randbereiche von Läsionen manchmal problematisch, lassen sich heute beispielsweise Metaplasien frühzeitig erkennen.



700700FX **Naso-Pharyngo-Laryngo-Fiberscope,**
 3.6 mm Ø, 300 mm length, incl.
 standard accessories.

Naso-Pharyngo-Laryngo-Fiberskop,
 3,6 mm Ø, 30 cm Länge, inkl.
 Standardzubehör.

700761FX **Naso-Pharyngo-Laryngo-Fiberscope,**
 slim version 2.8 mm Ø, 300 mm
 length, incl. standard accessories

Naso-Pharyngo-Laryngo-Fiberskop,
 schlanke Version 2,8 mm Ø, 30 cm
 Arbeitslänge, inkl. Standardzubehör.

700762FX **Naso-Pharyngo-Laryngo-Fiberscope,**
 4.2 mm Ø, 340 mm length incl.
 working channel 1.4 mm, with stan-
 dard + additional accessories

Naso-Pharyngo-Laryngo-Fiberskop,
 4,2 mm Ø, 34 cm Arbeitslänge, mit
 Arbeitskanal 1,4 mm, inkl. Standard-
 und Zusatzzubehör.

Specifications	Spezifikationen	700700FX	700761FX	700762FX
Working length	Arbeitslänge	300 mm	320 mm	320 mm
Diameter (distal)	Durchmesser (distal)	3.6 mm	2.8 mm	4.2 mm
Instrument channel	Instrumentenkanal	-	-	1.4 mm
Angle of view	Blickrichtung	0°	0°	0°
Field of view	Bildwinkel	85°	80°	80°
Depth of field	Schärfebereich	2.5 - 50 mm	1 - 50 mm	1 - 50 mm
Distal tip deflection	Distale Auslenkung			
upwards	aufwärts	125°	130°	130°
downwards	abwärts	125°	130°	130°

Set of Standard Accessories (including)

1 x Carrying Case
 1 x ETO Cap to ensure ventilation during gas sterilization
 1 x Standard Leakage Tester (complete)

Additional Accessories included in 700762FX

1 x Biopsy Forceps (1 mm Ø, length 120 cm)
 1 x Cap for biopsy channel
 1 x Cleaning Brush (1.5 mm Ø, length 110 cm)
 1 x Wire 1.0 mm
 Adapters (Wolf, Storz, Olympus)

Note:

For additional products and accessories please refer to the special catalogue "Laryngoscopy/Broncho-Oesophagoscopy".

Standardzubehör (in der Lieferung enthalten)

1 x Tragekoffer
 1 x ETO Entlüftungskappe für die Gassterilisation
 1 x Manometer zur Dichtigkeitsprüfung

Zusätzliches Zubehör beinhaltet bei 700762FX

1 x Biopsiezange (1 mm Ø, Länge 120 cm)
 1 x Verschlusskappe für Biopsiekanal
 1 x Reinigungsbürste (1,5 mm Ø, Länge 110 cm)
 1 x Draht 1,0 mm
 Adapter (Wolf, Storz, Olympus)

Hinweis:

Weitere Produkte und Zubehörartikel finden Sie im Spezialkatalog "Laryngoskopie / Broncho-Ösophagoskopie".

Flexible Biopsy Forceps
Flexible Biopsiezangen



Flexible Biopsy Forceps for Fiberscopes, double action jaw, cupped spoon 3 to 7 Fr.
Flexible Biopsie-Zangen für Fiberskope, doppelbewegliche Maulteile, runder Löffel von 3-7 Charr.

	Ref. No./Kat. Nr.	Outer Ø Außen Ø (mm)	Working length Nutzlänge (cm)
	518110FX	1.0	60
	518112FX	1.2	60
	518117FX	1.7	60
	518118FX	1.8	90
	518310FX	1.0	90
	518312FX	1.2	90
	518317FX	1.7	90
	518318FX	1.8	90
	518323FX	2.3	90
	518410FX	1.0	120
	518412FX	1.2	120
	518417FX	1.7	120
	518423FX	2.3	120

518324FX



Flexible Biopsy Forceps for Fiberscopes, Ø 2.3 mm, double action jaw, cupped spoon 7 Fr., fenestrated with mandrel, working length 90 cm
Flexible Biopsie-Zangen für Fiberskope, Ø 2,3 mm, doppelbewegliche Maulteile, Löffel 7 Charr., mit Fenster und Dorn, Arbeitslänge 90 cm

518424FX

Same, but with a working length of 120 cm
Gleich, aber mit einer Nutzlänge von 120 cm

Flexible Alligator Grasping Forceps for Fiberscopes, double action jaw, 3 to 7 Fr.
Flexible Fasszange für Fiberskope, doppelbewegliche Maulteile, 3-7 Charr.

	Ref. No./Kat. Nr.	Outer Ø Außen Ø (mm)	Working length Nutzlänge (cm)
	518210FX	1.0	60
	518212FX	1.2	60
	518217FX	1.7	60
	518510FX	1.0	90
	518512FX	1.2	90
	518517FX	1.7	90
	518518FX	1.8	90
	518523FX	2.3	90
	518610FX	1.0	120
	518612FX	1.2	120
	518617FX	1.7	120
	518623FX	2.3	120

Innovative Design – Quality Manufacturing

All components of our endoscopes are designed and manufactured in Germany strictly according to GMP standards. We only use the finest quality materials including medical grade stainless steel for the tubes and housings and other leakage resistant materials for optimal corrosion protection and high durability.

Innovatives Design – Hohe Fertigungsqualität

Alle Komponenten unserer Endoskope sind nach strengsten GMP Vorgaben konstruiert und in Deutschland gefertigt. Wir verwenden nur hochwertige Qualitätsmaterialien wie Edelstahl „Medical Grade“ für die Hüllrohre und das Hauptteil, sowie resistente Rohmaterialien für eine optimale Korrosionsbeständigkeit und Langlebigkeit des Instrumentes.

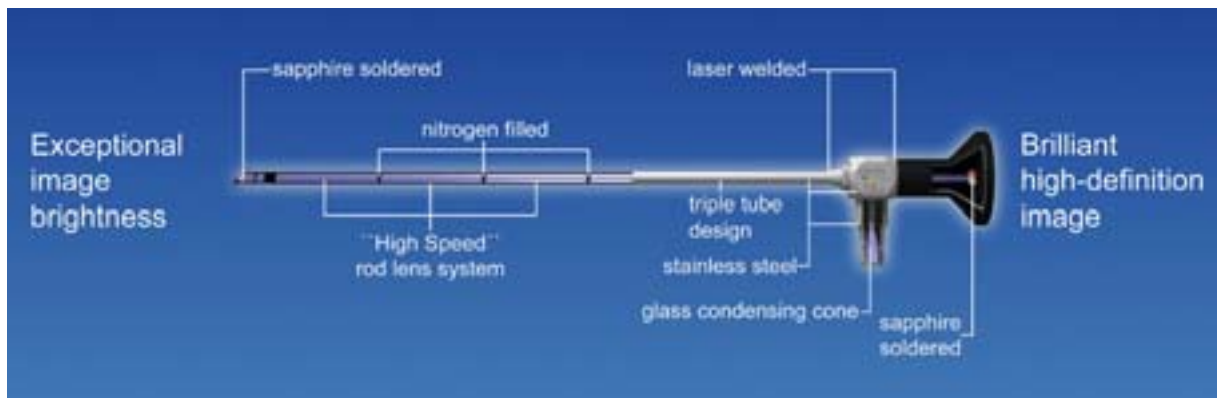

Unsurpassed Durability and Autoclave Standards

Laser-welded joints and scratch-resistant windows made from sapphire guarantee a clear view for many years of clinical use.

Thanks to these measures, the endoscopes are fully autoclavable and even withstand the French cycle of 18 minutes at 134° C / 273° F and 2.3 bar without problems.

Other leakage resistant materials for optimal corrosion protection and high durability.

Unübertroffene Autoklavierbeständigkeit

Lasergeschweißte Verbindungen und kratzresistente Saphirfenster garantieren ungetrübte Einblicke für viele Jahre des klinischen Einsatzes.

Durch diese Maßnahmen lassen sich die Endoskope uneingeschränkt autoklavieren und halten selbst dem französischen Zyklus mit 18 min. bei 134° C / 273° F und 2,3 bar problemlos stand.

Die Verwendung hochwertiger korrosionsbeständiger Materialien sichert die unübertroffene Langlebigkeit unserer Optiken.



Hi-View OPTIKEN

FENTEX – weltweit führende Visualisierungstechnik

Brilliant Optics

The newly designed "Hi-View" rod-lens system and the optimized glass fibre arrangement provide a more brilliant image with high resolution and extreme sharpness up to the edges. The improved optical system provides excellent detail recognition of the smallest visible anatomical structures.

We use special glass lenses of particularly enhanced light transmitting capacity and superior colour fidelity so that even high magnification of the image is possible without a major loss in quality.

Brillante optische Qualität

Das neu berechnete „Hi-View“ Stabliniensystem, sowie eine optimierte Glasfaseranordnung sorgen für ein brillantes Bild mit hoher Auflösung und enormer Schärfe, bis in den Randbereich hinein. Das verbesserte optische System bietet eine hervorragende Detailauflösung für die Differenzierung kleinster, sichtbarer anatomischer Strukturen.

Wir verwenden Speziallinsen aus besonders lichtstarkem Glas und hoher Farbtreue, so dass selbst starke Vergrößerungen ohne nennenswerte Qualitätseinbußen möglich sind.



More Light

The special light injection via an optical focusing cone inside the light connection of the endoscope supplies more light to the organ to be examined.

Einzigartige Bildhelligkeit

Die besondere Lichteinkopplung über einen optischen Fokussierkegel im Lichtanschluss des Endoskops bringt mehr Licht in das zu untersuchende Organ.



Important International Standards

- Autoclavability according to EN ISO 14161 and DIN 58946, tested with 500 cycles
- Quality Management System according to EN ISO 13485; 2003
- EC conformity according annex I of the MDD 93/42/EEC, CE 0123

Wichtige Internationale Standards und Normen

- Autoklavierbarkeit entsprechend EN ISO 14161 und DIN 58946, getestet mit 500 Zyklen
- Qualitätsmanagementsystem zertifiziert nach EN ISO 13485, 2003
- EC Konformität nach MDD 93/42/EWG, CE 0123

General Information

Allgemeine Informationen

Telescope Features and Dimensions

Abmessungen und Eigenschaften der Endoskope

Working Length

Arbeitslänge

The approximate length of the Endoscope shaft from the lock to the distal tip (in mm)

Die ungefähre Länge des Endoskopschaftes, vom Verschluss bis zur distalen Spitze (in mm)

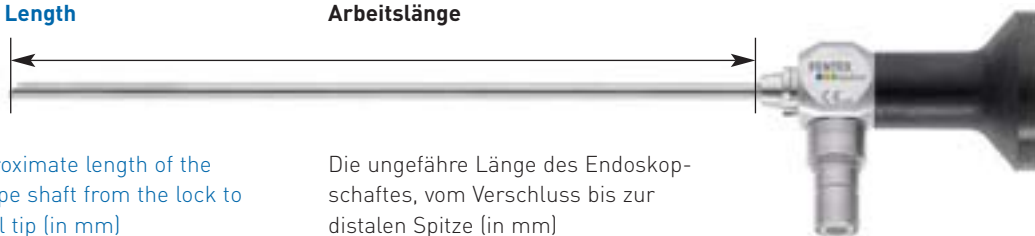

Field of View

Blickwinkel

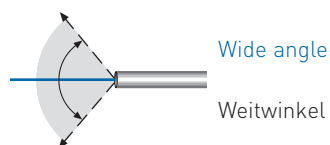
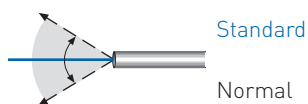

Direction of View

Blickrichtung

Direction of view is defined by the angle (deviation) between the middle beam and the axis of the optical system.

Die Blickrichtung in Grad [°] ergibt sich aus der Abweichung des Mittelpunktstrahls der Optik von der geometrischen Achse des Endoskopes.

Typical directions of View

Typische Blickrichtungen und ihre Bezeichnung

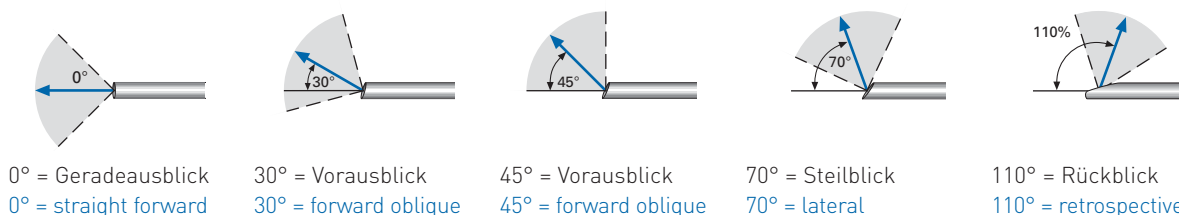

Autoclavability

Autoklavierbarkeit

All FENTEX endoscopes labelled "autoclavable" can be sterilized at 134°C/273°F for about 18 min. with 2.3 bar, which is defined as French cycle.

Alle FENTEX Endoskope, die das Label "autoclavable" tragen, sind bei 134°C/273°F sterilisierbar. Die Optiken können über 18 Min. bei 2,3 bar, dem sog. French Cycle autoklaviert werden.

All FENTEX endoscopes are soakable in disinfectants and cold disinfection with EO, FO, STERIS is also possible.

Alle starren Endoskope können vollständig in Desinfektionslösung eingelegt werden, bzw. sind in EO, FO, STERIS aufbereitbar.

We guarantee autoclavability for a minimum of 24 months. For maintenance or repair of your endoscope pls. refer to the FENTEX telescope exchange program.

Wir garantieren die volle Autoklavierbarkeit der Endoskopoptiken für 24 Monate. Informationen zur Wartung und Reparatur Ihres Endoskopes finden sie im FENTEX Optik-Austauschprogramm.



- autoclavable
- autoklavierbar

Rigid Telescopes for Broncho- / Esophagoscopy
Starre Endoskope für Broncho- / Oesophagoskopie

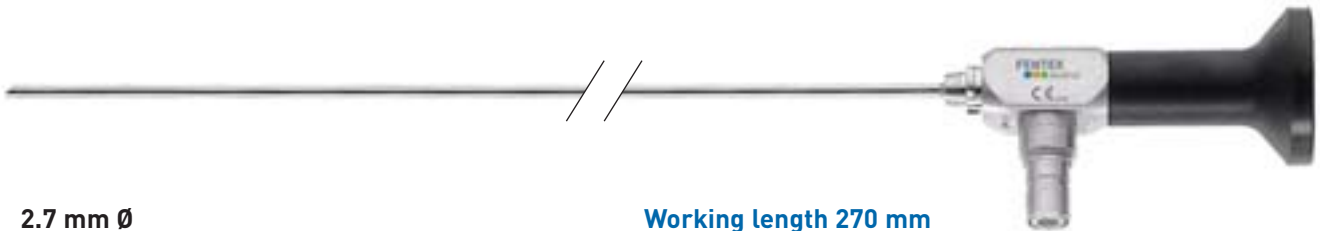

2.7 mm Ø

Working length 270 mm

Arbeitslänge 27 cm

701300FX



- autoclavable
- autoklavierbar

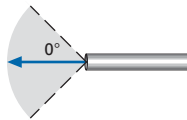

Hi-View Telescope, 0°, wide angle, 2.7 mm Ø, working length 270 mm, autoclavable

Hi-View Optik, 0°, Weitwinkel, 2,7 mm Ø, Arbeitslänge 27 cm, autoklavierbar

701330FX



- autoclavable
- autoklavierbar

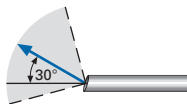

Hi-View Telescope, 30°, wide angle, 2.7 mm Ø, working length 270 mm, autoclavable

Hi-View Optik, 30°, Weitwinkel, 2,7 mm Ø, Arbeitslänge 27 cm, autoklavierbar

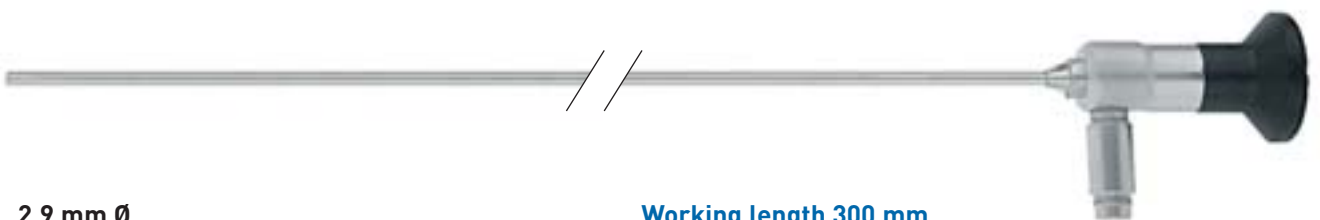

2.9 mm Ø

Working length 300 mm

Arbeitslänge 30 cm

703100FX



- autoclavable
- autoklavierbar

Hi-View Telescope, 0°, wide angle, 2.9 mm Ø, working length 300 mm, autoclavable

Hi-View Optik, 0°, Weitwinkel, 2,9 mm, Arbeitslänge 30 cm, autoklavierbar

703130FX



- autoclavable
- autoklavierbar

Hi-View Telescope, 30°, wide angle, 2.9 mm Ø, working length 300 mm, autoclavable

Hi-View Optik, 30°, Weitwinkel, 2,9 mm, Arbeitslänge 30 cm, autoklavierbar

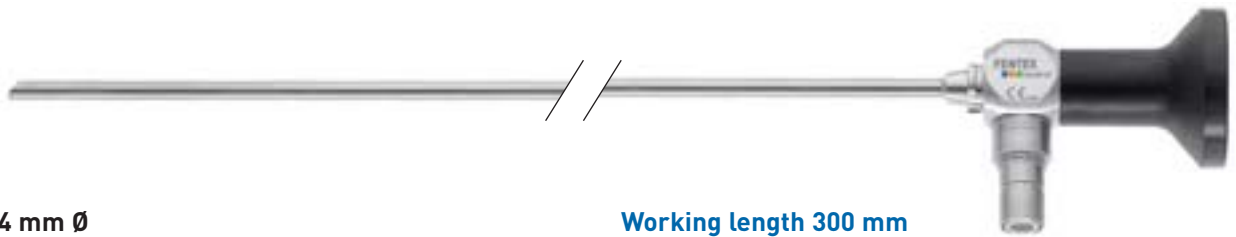

4 mm Ø

Working length 300 mm

Arbeitslänge 30 cm

700900FX



- autoclavable
- autoklavierbar

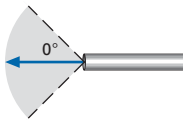

Hi-View Telescope, 0°, wide angle, 4 mm Ø, working length 300 mm, autoclavable

Hi-View Optik, 0°, Weitwinkel, 4 mm Ø, Arbeitslänge 30 cm, autoklavierbar

700930FX



- autoclavable
- autoklavierbar

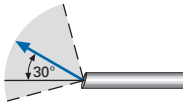

Hi-View Telescope, 30°, wide angle, 4 mm Ø, working length 300 mm, autoclavable

Hi-View Optik, 30°, Weitwinkel, 4 mm Ø, Arbeitslänge 30 cm, autoklavierbar

700970FX



- autoclavable
- autoklavierbar

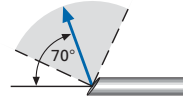

Hi-View Telescope, 70°, wide angle, 4 mm Ø, working length 300 mm, autoclavable

Hi-View Optik, 70°, Weitwinkel, 4 mm Ø, Arbeitslänge 30 cm, autoklavierbar

Non-autoclavable telescopes in 4 mm on request

Nicht autoklavierbare Endoskope in 4 mm auf Anfrage

Rigid Telescopes for Broncho- / Esophagoscopy
Starre Endoskope für Broncho- / Oesophagoskopie

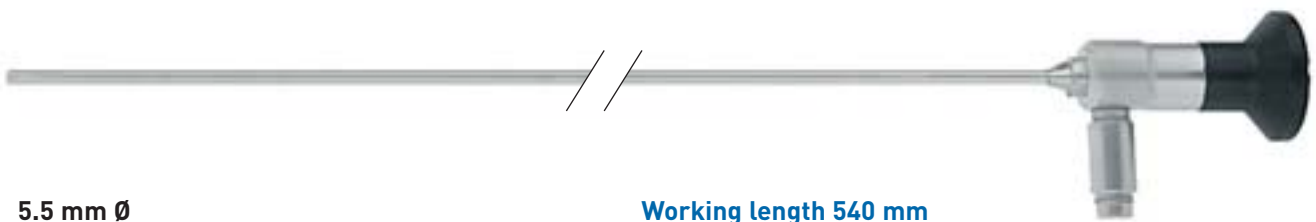

5.5 mm Ø

Working length 540 mm

Arbeitslänge 54 cm

702100FX



18 min
134°C

- autoclavable
- autoklavierbar

Hi-View Telescope, 0°, wide angle, 5.5 mm Ø, working length 540 mm, autoclavable

Hi-View Optik, 0°, Weitwinkel, 5,5 mm, Arbeitslänge 54 cm, autoklavierbar

702130FX



18 min
134°C

- autoclavable
- autoklavierbar

Hi-View Telescope, 30°, wide angle, 5.5 mm Ø, working length 540 mm, autoclavable

Hi-View Optik, 30°, Weitwinkel, 5,5 mm, Arbeitslänge 54 cm, autoklavierbar

Telescope Accessories
Zubehör für Endoskope



708591FX **Wire Basket I**, sterilization and storage of a single rigid telescope, including lid and silicone brackets, overall dimensions 290 x 80 x 52 mm

Siebkorb, kurz, zur Sterilisation und Lagerung einer starren Optik, inkl. Deckel und Silikonhalter, Gesamtabmessungen 290 x 80 x 52 mm

708592FX **same**, but overall dimensions 460 x 80 x 52 mm

wie oben, aber Gesamtabmessungen 460 x 80 x 52 mm

708590FX **Wire Basket II**, sterilization and storage of two rigid telescopes, incl. lid and silicone brackets, overall dimensions 290 x 80 x 52 mm

Siebkorb, kurz, zur Sterilisation und Lagerung von zwei starren Optiken, inkl. Deckel und Silikonhalter, Gesamtabmessungen 290 x 80 x 52 mm

708593FX **same**, but overall dimensions 460 x 80 x 52 mm

wie oben, aber Gesamtabmessungen 460 x 80 x 52 mm



740311FX **Telescope Handle**, flat serrated, 110 mm length, recommended for telescopes up to 4 mm Ø, 0°-70°, working length >150 mm

Endoskophandgriff, flach geriffelt, 11 cm Länge, empfohlen für Endoskope bis 4 mm Ø, 0°, Arbeitslänge >15 cm

740316FX **same**, but for telescopes up to 2.7 mm Ø
wie oben, aber für Endoskope bis 2,7 mm Ø



708570FX **Scope Case I**, plastic, sterilization and storage of a single rigid telescope Ø 1-10 mm, case size 271 x 70 x 35 mm

Optik Case I, Kunststoff, zur Sterilisation und Lagerung einer starren Optik Ø 1-10 mm, Größe 271 x 70 x 35 mm

708571FX **same**, but case size 394 x 70 x 35 mm

wie oben, aber Größe 394 x 70 x 35 mm

708572FX **Scope Case II**, plastic, sterilization and storage of two rigid telescopes Ø 1-10 mm, case size 394 x 70 x 35 mm

Optik Case II, Kunststoff, zur Sterilisation und Lagerung von zwei starren Optiken Ø 1-10 mm, Größe 394 x 70 x 35 mm



740312FX **Telescope Handle**, round serrated, 110 mm length, recommended for telescopes up to 4 mm Ø, 0°-70°, working length >150 mm

Endoskophandgriff, rund geriffelt, 11 cm Länge, empfohlen für Endoskope bis 4 mm Ø, 0°-70°, Arbeitslänge >15 cm



740313FX **Telescope Handle**, round serrated, 65 mm length, recommended for telescopes up to 4 mm Ø, 0°-70°, working length >75 mm

Endoskophandgriff, rund geriffelt, 6,5 cm Länge, empfohlen für Endoskope bis 4 mm Ø, 0°-70°, Arbeitslänge >7,5 cm

Telescope Accessories
Zubehör für Endoskope



118900FX Flexible Arm Attachment, with holding rod, for attachment to the OR-table or rail system

Flexibler Haltearm mit Spannvorrichtung und Befestigungsmöglichkeit am OP-Tisch oder Schienensystem



118901FX Mounting Bracket for Flexible Arm Attachment 118900FX to the OR-table

Halteklaue drehbar, zur Befestigung des flexiblen Haltearms 118900FX am OP-Tisch



118903FX Telescope Clamp for Flexible Arm 118900FX

Optikklammer für flexiblen Haltearm 118900FX



741200FX Protection Sheath for Telescopes, autoclavable (use 2 pcs. of 741200FX for telescopes with a working length of 270/300 mm)

Schutzhülse für Endoskopoptiken, autoklavierbar (benutzen Sie 2 Stück 741200FX für Optiken mit einer Länge von 270/300 mm)



863100FX ULTRA-STOP, 25 ml Solution (antifogging), Pipette Bottle

ULTRA-STOP, 25 ml Lösung (Antibeschlagentmittel), Pipettenflasche



863110FX ULTRA-STOP, 15 ml Solution (antifogging), Spray Bottle

ULTRA-STOP, 15 ml Lösung (Antibeschlagentmittel), Sprühflasche





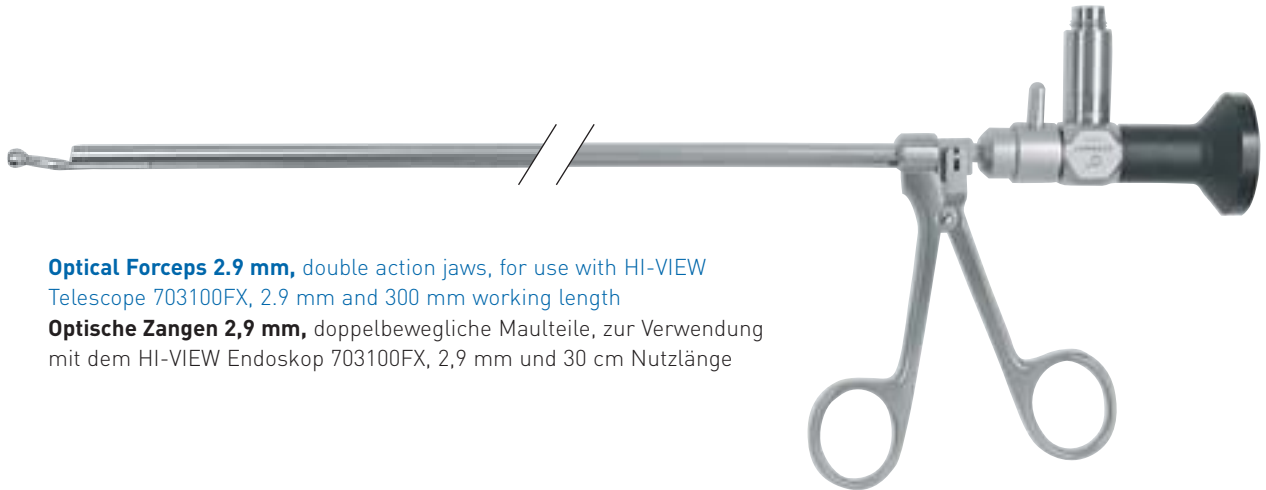

863101FX ULTRA-STOP, 25 ml Solution (antifogging), Pipette Bottle

ULTRA-STOP, 25 ml Lösung (Antibeschlagentmittel), Pipettenflasche









Optical Forceps 2.9 mm, double action jaws, for use with HI-VIEW Telescope 703100FX, 2.9 mm and 300 mm working length

Optische Zangen 2,9 mm, doppelbewegliche Maulteile, zur Verwendung mit dem HI-VIEW Endoskop 703100FX, 2,9 mm und 30 cm Nutzlänge

	Ref. No./Kat. Nr.	Description Beschreibung
	586530FX	Biopsy forceps w. cupped jaws, Ø 1.7 mm Probeexzisionszange m. Löffel, Ø 1,7 mm
	586630FX	Grasping forceps f. peanuts or soft foreign bodies Greifzange f. Erdnüsse und weiche Fremdkörper
	586730FX	Alligator grasping forceps for foreign bodies Greifzange m. Hechtmul
	586830FX	Universal grasping and biopsy forceps Universal Greif- und Biopsiezange







Optical Forceps 4 mm, double action jaws, for use with HI-VIEW Telescope 700900FX, 4 mm and 300 mm working length

Optische Zangen 4 mm, doppelbewegliche Maulteile, zur Verwendung mit dem HI-VIEW Endoskop 700900FX, 4 mm und 30 cm Nutzlänge

	Ref. No./Kat. Nr.	Description Beschreibung
	586534FX	Biopsy forceps w. cupped jaws, Ø 3.4 mm Probeexzisionszange m. Löffel, Ø 3,4 mm
	586543FX	Biopsy forceps w. cupped jaws, Ø 4.3 mm Probeexzisionszange m. Löffel, Ø 4,3 mm
	586634FX	Grasping forceps f. peanuts or soft foreign bodies Greifzange f. Erdnüsse und weiche Fremdkörper
	586734FX	Alligator grasping forceps for foreign bodies Greifzange m. Hechtmul
	586834FX	Universal grasping and biopsy forceps Universal Greif- und Biopsiezange
	586934FX	Scissors Hook End Hakenschere

Optical Forceps 5.5 mm, double action jaws, for use with HI-VIEW Telescope 702100FX, 5.5 mm and 540 mm working length

Optische Zangen 5,5 mm, doppelbewegliche Maulteile, zur Verwendung mit dem HI-VIEW Endoskop 70210FX, 5,5 mm und 54 cm Nutzlänge

	Ref. No./Kat. Nr.	Description Beschreibung
	586550FX	Biopsy forceps w. cupped jaws, Ø 4.3 mm Probeexzisionszange m. Löffel, Ø 4,3 mm
	586553FX	Biopsy forceps w. cupped jaws, Ø 3.3 mm Probeexzisionszange m. Löffel, Ø 3,3 mm
	586650FX	Grasping forceps f. peanuts or soft foreign bodies Greifzange f. Erdnüsse und weiche Fremdkörper
	586750FX	Alligator grasping forceps for foreign bodies Greifzange m. Hechtmaul
	586850FX	Universal grasping and biopsy forceps Universal Greif- und Biopsiezange
	586950FX	Scissors Hook End Hakenschere

Broncho Esophagoscopic Forceps
Broncho-Oesophagoskopie Zangen







**531404FX-
531735FX**



Broncho-Esophagoscopic Forceps by JACKSON,
with standard-shaft, upper jaws moveable
Broncho-Oesophagoskopie Zangen nach Jackson,
mit Schienenschaft, obere Maulteile beweglich

**532404FX-
532735FX**

Same, but double action jaws
Gleich, aber beide Maulteile beweglich

Working length Schaftlänge					
30 cm	531404FX	531405FX	531406FX	532404FX	532406FX
40 cm	531504FX	531505FX	531506FX	532504FX	532506FX
50 cm	531604FX	531605FX	531606FX	532604FX	532606FX
60 cm	531704FX	531705FX	531706FX	532704FX	532706FX

Working length Schaftlänge						
	Ø 2 mm	Ø 4 mm	Ø 2 mm	Ø 4 mm		
30 cm	531412FX	531413FX	531417FX	531419FX	532414FX	532420FX
40 cm	531512FX	531513FX	531517FX	531519FX	532514FX	532520FX
50 cm	531612FX	531613FX	531617FX	531619FX	532614FX	532620FX
60 cm	531712FX	531713FX	531717FX	531719FX	532714FX	532720FX

Working length Schaftlänge					
30 cm	531420FX	531431FX	531435FX	532431FX	532435FX
40 cm	531520FX	531531FX	531535FX	532531FX	532535FX
50 cm	531620FX	531631FX	531635FX	532631FX	532635FX
60 cm	531720FX	531731FX	531735FX	532731FX	532735FX













Broncho Esophagoscopic Forceps
Broncho-Oesophagoskopie Zangen



540950FX- **Broncho-Esophagoscopic Forceps**, tube shaft Ø 2.5 mm
560996FX **Broncho-Oesophagoskopiezangen**, Rohrschaft Ø 2,5 mm

535810FX- **Laryngoscopy and Children Bronchoscopy Forceps**,
tube shaft Ø 1.5 mm & 350 mm length

535916FX **Laryngoskopie und Kinder-Bronchoskopiezangen**,
Rohrschaft Ø 1,5 mm & 35 cm Länge

Working length Schaftlänge Shaft Ø / Schaft Ø	40 cm 2.5 mm	50 cm 2.5 mm	60 cm 2.5 mm	35 cm 1.5 mm
	540950FX	550950FX	560950FX	-
	540962FX	550962FX	560962FX	535810FX
	540964FX	550964FX	560964FX	535830FX
	540966FX	550966FX	560966FX	535832FX
	540976FX	550976FX	560976FX	535890FX
	540978FX	550978FX	560978FX	535892FX
	540979FX	550979FX	560979FX	535893FX
	540982FX	550982FX	560982FX	535894FX
	540984FX	550984FX	560984FX	535896FX
	540990FX	550990FX	560990FX	-
	540992FX	550992FX	560992FX	535912FX
	540994FX	550994FX	560994FX	535914FX
	540996FX	550996FX	560996FX	535916FX

Broncho Esophagoscopic Forceps
Broncho-Oesophagoskopie Zangen

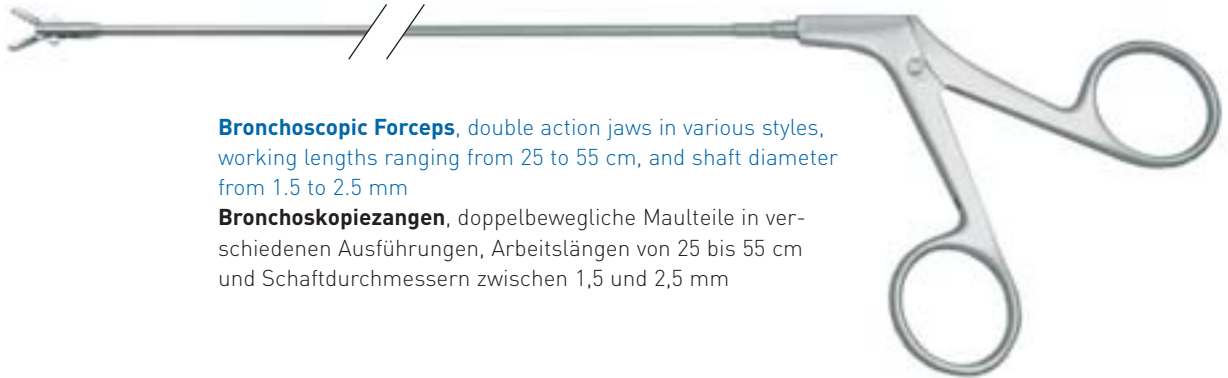

Bronchoscopic Forceps, double action jaws in various styles, working lengths ranging from 25 to 55 cm, and shaft diameter from 1.5 to 2.5 mm

Bronchoskopiezangen, doppelbewegliche Maulteile in verschiedenen Ausführungen, Arbeitslängen von 25 bis 55 cm und Schaftdurchmessern zwischen 1,5 und 2,5 mm

Working length Schaftlänge Shaft Ø Schaft Ø	25 cm 1.5 mm	35 cm 1.5 mm	35 cm 2.0 mm	45 cm 2.5 mm	55 cm 2.5 mm	Description Beschreibung
	585225FX	585235FX	585240FX	585245FX	585250FX	Foreign Body Forceps, alligator jaws Fremdkörperzange mit Hechtmaul
	585325FX	585335FX	585340FX	585345FX	585350FX	Universal Biopsy and Grasping Forceps Universalzange zur Biopsie
	585425FX	585435FX	585440FX	585445FX	585450FX	Cup Biopsy Forceps, straight Löffelzange, rund, gerade
	585525FX	585535FX	585540FX	585545FX	585550FX	Grasping Forceps for peanuts Zange für Erdnüsse und weiche Fremdkörper

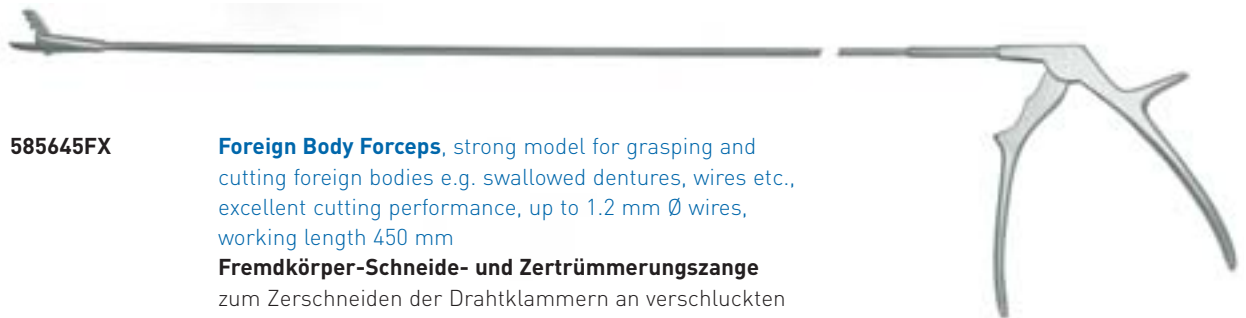

585645FX

Foreign Body Forceps, strong model for grasping and cutting foreign bodies e.g. swallowed dentures, wires etc., excellent cutting performance, up to 1.2 mm Ø wires, working length 450 mm

Fremdkörper-Schneide- und Zertrümmerungszange
zum Zerschneiden der Drahtklammern an verschluckten Zahnprothesen, exzellente Schneidkraft bis ca. 1,2 mm Draht, Nutzlänge 45 cm

585635FX

Same, but working length 350 mm
Gleich, aber Nutzlänge 35 cm

Accessories for Bronchoscopy

Zubehör für Bronchoskopie

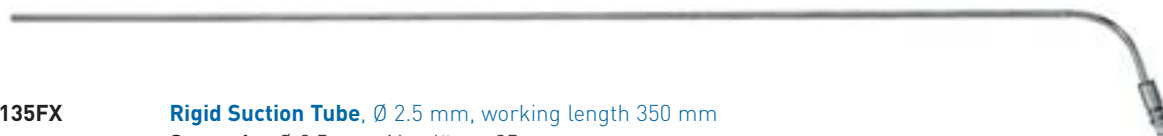

518135FX **Rigid Suction Tube**, Ø 2.5 mm, working length 350 mm
Saugrohr, Ø 2,5 mm, Nutzlänge 35 cm

518140FX **Same**, but working length 400 mm
Gleich, aber Nutzlänge 40 cm

518150FX **Same**, but Ø 4 mm, working length 500 mm
Gleich, aber Ø 4 mm, Nutzlänge 50 cm

518155FX **Same**, but Ø 4 mm, working length 550 mm
Gleich, aber Ø 4 mm, Nutzlänge 55 cm

518160FX **Same**, but Ø 4 mm, working length 600 mm
Gleich, aber Ø 4 mm, Nutzlänge 60 cm

518180FX **Same**, but Ø 4 mm, working length 180 mm
Gleich, aber Ø 4 mm, Nutzlänge 18 cm

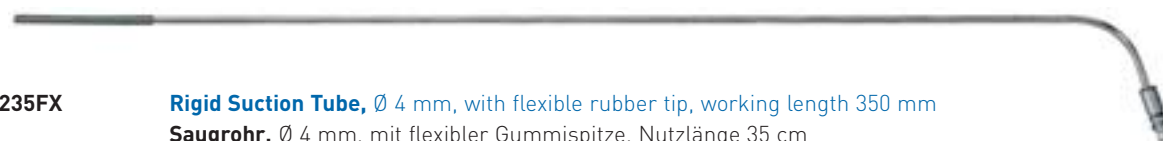

518235FX **Rigid Suction Tube**, Ø 4 mm, with flexible rubber tip, working length 350 mm
Saugrohr, Ø 4 mm, mit flexibler Gummispitze, Nutzlänge 35 cm

518250FX **Same**, but working length 500 mm
Gleich, aber Nutzlänge 50 cm



518435FX **Cotton Carrier**, working length 350 mm
Watteträger, Nutzlänge 35 cm

518450FX **Same**, but working length 500 mm
Gleich, aber Nutzlänge 50 cm

518460FX **Same**, but working length 600 mm
Gleich, aber Nutzlänge 60 cm

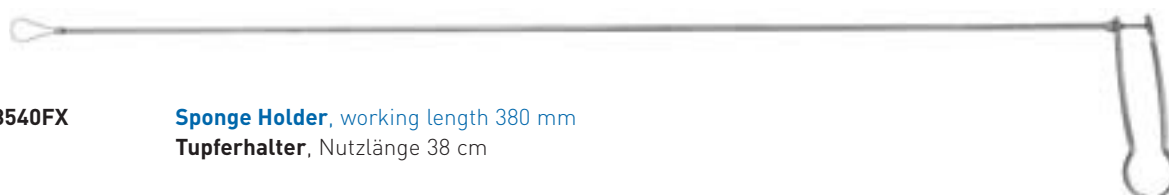

518540FX **Sponge Holder**, working length 380 mm
Tupferhalter, Nutzlänge 38 cm

518560FX **Same**, but working length 600 mm
Gleich, aber Nutzlänge 60 cm

Instrument Storage & Sterilization Instrumentenlagerung und Sterilisation



708230FX

Sterilisation Container, light weight aluminium, designed for steam-sterilization, storage, transport and sterile presentation, outer dimensions 600 x 270 x 130 mm (inner dimensions 554 x 254 x 105 mm), double lid with re-usable sterile barrier

Sterilisations-Container, leichter Metallcontainer für die Dampfsterilisation, Lagerung und den Transport innerhalb der Klinik. Außenabmessungen 600 x 270 x 130 mm (Innenabmessungen 554 x 254 x 105 mm), doppelwandiger Deckel mit wieder verwendbarer Sterilbarriere

708503FX

Instrument Tray, stainless steel wire mesh reinforced
Instrumenten-Siebschale, Edelstahl-Drahtgeflecht, mit verstärktem Rand



186300FX

Magnetic Instrument Rack, large size 480 x 240 x 40 mm, with 3 magnetic stripes for holding laryngoscopic instruments

Magnetrahmen für Instrumente, Größe 480 x 240 x 40 mm, mit drei Magnetreihen zum Halten der Laryngoskopie-Instrumente

186302FX

Magnetic Instrument Rack, size 480 x 185 x 40 mm, with 2 magnetic stripes for holding laryngoscopic instruments

Magnetrahmen für Instrumente, Größe 480 x 185 x 40 mm, mit zwei Magnetreihen zum Halten der Laryngoskopie-Instrumente



187903FX

Instrument Tray w. Lid, stainless steel, size 500 x 270 x 70 mm, for magnetic racks 186300FX and 186302FX

Instrumentenschale mit Deckel, Edelstahlausführung, Größe 500 x 270 x 70 mm, für Magnetrahmen 186300FX und 186302FX

Please refer to section 9 for additional storage trays and containers

Weitere Lagerungs- und Sterilisationscontainer finden Sie im Abschnitt 9

Index

Nummernverzeichnis

Kat. Nr. Cat. No.	Seite Page	Kat. Nr. Cat. No.	Seite Page	Kat. Nr. Cat. No.	Seite Page	Kat. Nr. Cat. No.	Seite Page
011302FX	19	054214FX	18	186302FX	64	470206FX	33
011305FX	19	054216FX	18	187903FX	64	470207FX	33
011310FX	19	054218FX	18	463000FX	28	470208FX	33
011402FX	19	054220FX	18	463100FX	28	470209FX	33
011405FX	19	054222FX	18	463200FX	28	480100FX	33
011410FX	19	054224FX	18	463300FX	28	480101FX	33
011500FX	19	054226FX	18	463400FX	27	480102FX	33
053700FX	16	054228FX	18	463600FX	29	480103FX	33
053701FX	16	054400FX	17	464100FX	30	480104FX	33
053702FX	16	054401FX	17	464200FX	30	480105FX	33
053703FX	16	054402FX	17	465118FX	30	480106FX	33
053704FX	16	054403FX	17	465318FX	30	480107FX	33
053705FX	16	054404FX	17	465418FX	30	480108FX	33
053706FX	16	054405FX	17	465618FX	30	480109FX	33
053707FX	16	054406FX	17	467000FX	31	480200FX	33
053708FX	16	054407FX	17	467101FX	31	480201FX	33
053709FX	16	054408FX	17	467102FX	31	480202FX	33
053710FX	16	054409FX	17	467103FX	31	480203FX	33
053720FX	16	054410FX	17	467104FX	31	480204FX	33
053800FX	16	054420FX	17	467600FX	26	480205FX	33
054000FX	16	055100FX	22	467707FX	26	480206FX	33
054001FX	16	056100FX	21	467805FX	26	480207FX	33
054002FX	16	056200FX	21	467807FX	26	480208FX	33
054003FX	16	056300FX	21	467809FX	26	480209FX	33
054004FX	16	057301FX	23	468101FX	31	490104FX	34
054005FX	16	057302FX	23	468102FX	31	490105FX	34
054006FX	16	057303FX	23	468103FX	31	490106FX	34
054007FX	16	057304FX	23	468104FX	31	490107FX	34
054008FX	16	057500FX	23	469108FX	27	490108FX	34
054009FX	16	057501FX	23	469110FX	27	490109FX	34
054010FX	16	057502FX	23	469317FX	27	490204FX	34
054020FX	16	057503FX	23	470100FX	33	490205FX	34
054100FX	17	058100FX	22	470101FX	33	490206FX	34
054101FX	17	084114FX	32	470102FX	33	490207FX	34
054102FX	17	084214FX	32	470103FX	33	490208FX	34
054103FX	17	084314FX	32	470104FX	33	490209FX	34
054104FX	17	084414FX	32	470105FX	33	515817FX	49
054105FX	17	085712FX	29	470106FX	33	518110FX	49
054106FX	17	085714FX	29	470107FX	33	518112FX	49
054107FX	17	085812FX	29	470108FX	33	518117FX	49
054108FX	17	085814FX	29	470109FX	33	518118FX	49
054109FX	17	086814FX	29	470200FX	33	518135FX	63
054110FX	17	118900FX	57	470201FX	33	518140FX	63
054120FX	17	118902FX	57	470202FX	33	518150FX	63
054200FX	17	118903FX	57	470203FX	33	518155FX	63
054210FX	18	164200FX	44	470204FX	33	518160FX	63
054212FX	18	186300FX	64	470205FX	33	518180FX	63

Nummernverzeichnis

Kat. Nr. Cat. No.	Seite Page	Kat. Nr. Cat. No.	Seite Page	Kat. Nr. Cat. No.	Seite Page	Kat. Nr. Cat. No.	Seite Page
518210FX	49	530206FX	8	531713FX	60	532137FX	43
518212FX	49	530207FX	8	531717FX	60	532138FX	43
518235FX	63	530210FX	9	531719FX	60	532140FX	37
518250FX	63	530211FX	9	531720FX	60	532141FX	37
518310FX	49	530213FX	9	531731FX	60	532142FX	37
518312FX	49	530300FX	10	531735FX	60	532143FX	37
518317FX	49	530301FX	10	532002FX	41	532144FX	37
518318FX	49	530302FX	10	532003FX	41	532146FX	37
518323FX	49	530303FX	10	532004FX	41	532150FX	36
518410FX	49	530304FX	10	532005FX	41	532151FX	36
518412FX	49	530500FX	6	532006FX	41	532152FX	36
518417FX	49	530501FX	6	532007FX	41	532153FX	36
518423FX	49	530600FX	6	532010FX	41	532154FX	38
518435FX	63	531404FX	60	532020FX	41	532155FX	38
518450FX	63	531405FX	60	532021FX	41	532156FX	38
518460FX	63	531406FX	60	532022FX	41	532157FX	39
518510FX	49	531412FX	60	532023FX	41	532158FX	38
518512FX	49	531413FX	60	532030FX	41	532159FX	38
518517FX	49	531417FX	60	532101FX	36	532160FX	40
518518FX	49	531419FX	60	532102FX	36	532161FX	40
518523FX	49	531420FX	60	532103FX	36	532163FX	40
518540FX	63	531431FX	60	532104FX	36	532164FX	40
518560FX	63	531435FX	60	532105FX	38	532165FX	40
518612FX	49	531504FX	60	532106FX	38	532168FX	38
518617FX	49	531505FX	60	532107FX	38	532169FX	38
518623FX	49	531506FX	60	532108FX	39	532170FX	40
520170FX	13	531512FX	60	532109FX	39	532171FX	40
520190FX	13	531513FX	60	532110FX	39,42	532172FX	40
520970FX	14	531517FX	60	532111FX	39,42	532173FX	40
521170FX	13	531519FX	60	532113FX	44	532176FX	40
521190FX	13	531520FX	60	532114FX	44	532177FX	40
521670FX	12	531531FX	60	532115FX	44	532180FX	39
521671FX	12	531535FX	60	532116FX	44	532181FX	39
530101FX	7	531604FX	60	532117FX	44	532182FX	39
530102FX	7	531605FX	60	532118FX	44	532183FX	39
530103FX	7	531606FX	60	532119FX	44	532200FX	43
530104FX	7	531612FX	60	532120FX	44	532201FX	42
530105FX	7	531613FX	60	532121FX	44	532202FX	42
530106FX	7	531617FX	60	532122FX	44	532203FX	42
530107FX	7	531619FX	60	532123FX	44	532204FX	42
530110FX	9	531620FX	60	532124FX	44	532205FX	38
530111FX	9	531631FX	60	532125FX	44	532208FX	42
530201FX	8	531635FX	60	532126FX	45	532209FX	42
530202FX	8	531704FX	60	532127FX	45	532215FX	39
530203FX	8	531705FX	60	532128FX	45	532228FX	45
530204FX	8	531706FX	60	532130FX	45	532230FX	46
530205FX	8	531712FX	60	532136FX	43	532231FX	46

Index

Nummernverzeichnis

Kat. Nr. Cat. No.	Seite Page	Kat. Nr. Cat. No.	Seite Page	Kat. Nr. Cat. No.	Seite Page	Kat. Nr. Cat. No.	Seite Page
532250FX	36	540962FX	61	560996FX	61	700761FX	48
532251FX	36	540964FX	61	561001FX	25	700762FX	47
532252FX	36	540966FX	61	561713FX	25	700762FX	48
532254FX	38	540976FX	61	562901FX	25	700900FX	54
532262FX	40	540978FX	61	563001FX	25	700930FX	54
532300FX	43	540979FX	61	578610FX	49	700970FX	54
532303FX	35	540982FX	61	583934FX	58	701300FX	53
532306FX	35	540984FX	61	585225FX	62	701330FX	53
532307FX	35	540990FX	61	585235FX	62	702100FX	55
532310FX	35	540992FX	61	585240FX	62	702130FX	55
532315FX	38	540994FX	61	585245FX	62	703100FX	53
532404FX	60	540996FX	61	585250FX	62	703130FX	53
532406FX	60	541125FX	46	585325FX	62	708230FX	64
532414FX	60	541130FX	46	585335FX	62	708503FX	64
532420FX	60	541133FX	46	585340FX	62	708570FX	56
532431FX	60	541230FX	45	585345FX	62	708571FX	56
532435FX	60	550950FX	61	585350FX	62	708572FX	56
532504FX	60	550962FX	61	585425FX	62	708590FX	56
532506FX	60	550964FX	61	585435FX	62	708591FX	56
532514FX	60	550966FX	61	585440FX	62	708592FX	56
532520FX	60	550976FX	61	585445FX	62	708593FX	56
532531FX	60	550978FX	61	585450FX	62	716500FX	15
532535FX	60	550979FX	61	585525FX	62	716700FX	15
532604FX	60	550982FX	61	585535FX	62	717500FX	18
532606FX	60	550984FX	61	585540FX	62	740311FX	56
532614FX	60	550990FX	61	585545FX	62	740312FX	56
532620FX	60	550992FX	61	585550FX	62	740313FX	56
532631FX	60	550994FX	61	585635FX	62	740316FX	56
532635FX	60	550996FX	61	585645FX	62	741200FX	57
532704FX	60	558201FX	24	586530FX	58	750270FX	14
532706FX	60	558620FX	24	586534FX	58	840402FX	20
532714FX	60	558630FX	24	586543FX	58	840403FX	20
532720FX	60	560101FX	24	586550FX	59	840404FX	20
532731FX	60	560501FX	25	586553FX	59	863100FX	15,57
532735FX	60	560901FX	25	586630FX	58	863101FX	15,57
535810FX	61	560950FX	61	586634FX	58	863110FX	15,57
535830FX	61	560962FX	61	586650FX	59	863110FX	57
535832FX	61	560964FX	61	586730FX	58	896100FX	11
535890FX	61	560966FX	61	586734FX	58	896150FX	11
535892FX	61	560976FX	61	586750FX	59	896160FX	11
535893FX	61	560978FX	61	586830FX	58	896200FX	11
535894FX	61	560979FX	61	586834FX	58	896201FX	11
535896FX	61	560982FX	61	586850FX	59	896202FX	11
535912FX	61	560984FX	61	586950FX	59	896203FX	11
535914FX	61	560990FX	61	700700FX	47		
535916FX	61	560992FX	61	700700FX	48		
540950FX	61	560994FX	61	700761FX	47		

Company Mission

To offer highly valued, innovative solutions to medical needs with a focus on the treatment of patients with head & neck disorders. We fully support the medical profession in achieving optimal results (functionally and aesthetically) when treating their patients.

We do this

- *By providing the best quality surgical products at affordable cost*
- *By establishing and maintaining a technically competent sales and support organization*
- *By facilitating excellent training and education to all our partners*
- *By helping surgeons to develop new procedures and products*
- *By emphasizing what is best for our company as a whole, never sacrificing the quality of our products or services in order to enhance profits.*
- *By adhering to the highest professional standards in all activities*

FENTEXmedical GmbH

take-off GewerbePark
D-78579 Neuhausen ob Eck
Germany

Tel. +49 (0) 7467 - 949 62 0
Fax +49 (0) 7467 - 949 62 17

info@fentexmedical.com
www.fentexmedical.com

FENTEX Instruments - Made in Germany

